

MAGPUL®





EVERYWHERE:

2016 was a year marked with growth, with expanded capacities, with new areas of development, and with some challenges in balancing it all during intense demand. Along with all this, we managed to find some time to seek inspiration with Magpul and Magpul Core activities in Baja for the Trail of Missions, in Africa for some conservation and management hunts, and back to Nepal to set some world records with our friends from CPS. Our media projects chronicle these adventures in the projects titled “Everywhere: Baja”, “Everywhere: Nepal”, and others.

All of this adds up to some exciting things coming in 2017, as evidenced by the sheer size that this publication has grown to, coupled with many more items coming later in the year and some very interesting developments that won’t be ready until 2018 and beyond. The team at Magpul has grown, and our ability to diversify into new areas without compromising any of the efforts we put into our core products has grown with it.

The overall goal, of course, is to bring you the same Magpul value and innovation to an increasing number of product categories, but only when they make sense to release. The very same foundations on which we were founded to bring you the highest quality firearm accessories in the world make a great starting point to bring you Magpul...everywhere.



T.O.C.

MAGAZINES	006	
BOLT ACTION	028	
RIMFIRE	034	
KALASHNIKOV	042	
SHOTGUN	054	
HANDGUN	062	
STOCKS	072	
GRIPS	090	
M-LOK ACCESSORIES	102	
HAND GUARDS	118	
SIGHTS	126	
SLING SYSTEMS	132	
TOOLS	140	
ACCESSORIES	144	
GEAR	148	
KNOWLEDGE PRODUCTS	162	
MAGPUL CORE	164	

Many of the products in this catalog are controlled by the U.S. government and authorized for export only to the country of ultimate destination for use by the ultimate consignee or end-user(s) identified. They may not be resold, transferred or otherwise disposed of, to any other country or to any person other than the authorized ultimate consignee or end-user(s) either in their original form or after being incorporated into other items, without first obtaining approval from the U.S. government or as otherwise authorized by U.S. laws and regulations.

©2017 Magpul Industries Corporation. All Rights Reserved. Prices subject to change without notice. MAGPUL holds a Trademark on all of its product names and logos. Full information at ip.magpul.com. The following are either trademarks or registered trademarks of Magpul Industries Corporation in the U.S. and other countries; Magpul, "The Magpul Logo & Design", "The Magpul Inner Logo & Design", "The Stylized Magpul Logo & Design", ACS, ACS-L, AFG, AFG-2, "AKA KOA & Design", ASAP, AUS, B.A.D. Lever, BEV, Magpul CORE, "CORE & Design", "Magpul CORE Logo & Design", CTR, EMAG, Enhanced Self-Leveling Follower, GEN M3, GL9, L-Plate, M-LOK, "M M-LOK & Design", "M & Design", Maglink, Magpul Dynamics, "The Magpul Dynamics Logo & Design", MagLevel, Magpul X-22, MBUS, MBUS Pro, MIAD, MOE, MOE+, MOE-K, MOE-K2, MOE-K2+, MOE SL, MS1, MS3, MS4, MSA, MV6, PMAG, PMAG 5 AC, PMAG D-60, PRS, PRS2, ParaClip, Ranger Plate, RSA, RVG, SGA, SpeedPlate, Speedthreader, SSG, STR, THEORY BASED PRODUCTS, "Skeleton & Design", "TEJAS GUN BELT EL ORIGINAL & Design", "TEJAS GUN BELT EL BURRO & Design", "Burro & Design", UBR, "UDAKA & Design", Unfair Advantage, XTM "The Tenth Anniversary Skull Emblem & Design", "Revitalizing American Manufacturing Logo & Design" Zhukov-S. Melonite is a registered trademark of Durferrit GmbH, LLC. Remington is a registered trademark of RA Brands, LLC. FN and SCAR are registered trademarks of FN Herstal S.A. HK is a registered trademark of Heckler & Koch GmbH. MASH HOOK is a registered trademark of ITW Waterbury Buckle. Glock is a registered trademark of Glock GmbH. UltiMAK is a Trademark of UltiMAK, Inc. Manfroto is a registered trademark of Lino Manfroto + co. Spa. Everlube is a registered trademark of Everlube Corporation of America, Ruger is a registered trademark of Sturm, Ruger & Company, Inc. SIG SAUER is a registered trademark of Sig Sauer, Inc. SureFire and SCOUT LIGHT are registered trademarks of Surefire, LLC. Mossberg is a registered trademark of O.F. Mossberg & Sons, Inc. Winchester is a trademark of Olin Corporation, Insight is a trademark of L-3 Warrior Systems, Drirelease is a registered trademark of Optimer Performance Fibers, Inc., Nomex and Kevlar are registered trademarks of Du Pont de Nemours and Company, YKK is a registered trademark of YKK Corporation, MALICE CLIP is a registered trademark of Logan Coffey, iPhone and iPad are registered trademarks of Apple, Inc. Samsung and GALAXY S are registered trademarks of Samsung Electronics Co., Ltd.

PHOTO CREDITS: Magpul Marketing Department, Evan Kubik, Paul-Henry de Baere

MAGAZINES

10 YEARS OF REDEFINING MAGAZINE PERFORMANCE.

In 2007, the firearms magazine market changed forever. It was the realization of an idea that a polymer magazine could not only meet, but exceed, the durability and reliability of the USGI aluminum AR-15 magazine. The PMAG wasn't the first polymer AR-15 magazine, of course, but it was the first one that you could rely on. The writing on the wall was undeniable, and that ingenuity and performance spread across a wide variety of platforms. The tenth year of the PMAG sees it continue its de facto position as the gold standard in magazine performance.

Our entire line of magazines is designed, manufactured, and tested to exceed anything you're likely to ask of them, using demanding scientific testing procedures that go beyond what others consider "requirements", and including a decade on the battlefield as the most-fielded polymer magazine for the AR15/M4 family of weapons platforms.

A magazine needs to do several things really well. It needs to feed as near to flawless as possible, in all compatible platforms under both normal and adverse conditions. It also needs to resist damage due to rough handling, abuse, impacts, and other hazards of extreme use. Balancing those requirements is difficult. Dominating them is...Magpul.

GEN M3 The GEN M3 series is in its fifth year of production, and has proven to be the most reliable, durable series of magazines available for the AR platform in both internal and third party testing, to include the US Government. The GEN M3 MCT magazine is the perfect storm of desired color and uncompromising performance for military applications. Reflecting on the last decade is encouraging, but focusing on the next decade is what drives us at Magpul. The PMAG line will endure and expand as it always has.



HOW THE PMAG MAGLEVEL WORKS

The MagLevel round indicator system allows for visual verification of a magazine's loaded round count via a bright orange indicator coil. By incorporating a window on both sides of the magazine, it is easily used by both right and left handed shooters. The indicator coil and window give the user an indication of remaining rounds until the magazine is empty rather than losing all indicators when the round stack enters the magazine well, as in other "visible round count" systems.

MAGLEVEL

ORANGE INDICATOR COIL
POINTS TO ROUNDS
REMAINING IN MAGAZINE

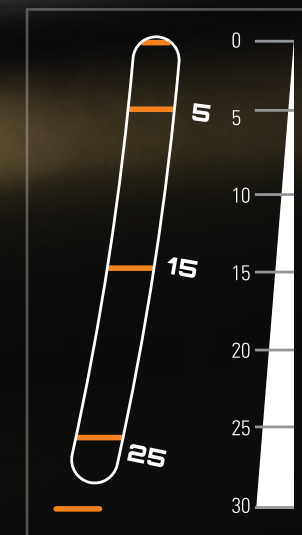



MAGPUL

MEDIUM COYOTE TAN (MCT) PMAGs

MAG556 | **MSRP \$17.95** | 5.56 NATO / .223 REMINGTON

MAG557 | **MSRP \$14.95** | 5.56 NATO / .223 REMINGTON

Engineered to combine the unmatched performance of the PMAG 30 AR/M4 GEN M3 Window and the desired color for the U.S. Army's Small Arms Weapons Neutral signature reduction program. The "MCT Mag" carries forward all of the prior GEN M3 innovations to include our next-generation impact and crush resistant polymer, aggressive front and rear texture, an easily removable slim floor plate, a paint pen dot matrix for marking and identification, and a dust/impact cover as well as the Maglevel window to indicate capacity at a glance. The MCT mag utilizes a newly developed proprietary molding process to allow for desired colors while maintaining the absolute strength and performance of the black and sand materials previously available. In addition, the MCT mag carries forward the existing GEN M3 5.56 feed geometry to ensure M855A1 feeds with greater reliability than other magazines and eliminates premature wear in the M4, M16, and M27 IAR.

GEN M3

NEW PRODUCT



MAGAZINES

NEW PRODUCT

PMAG 30 AR 300 B GEN M3

MAG800 | **MSRP \$15.95** | 7.62X35 / .300 BLACKOUT

The PMAG 30 AR 300 B GEN M3 is a purpose-designed magazine for rifles chambered in .300 Blackout. Since its inception, .300 Blackout shooters have had to use a magazine designed for another cartridge, limiting its performance and compatibility. One of the nice features of .300 Blackout is the compatibility with 5.56x45mm parts, but with the magazine it is a compromise to do so. Due to the wide variety of projectile weights and shapes potentially decreasing overall reliability, a dedicated .300 Blackout magazine was a logical step for the PMAG line.

In addition to the performance gained by a dedicated mag, the PMAG 30 AR 300 B also offers a safer way to feed your .300 BLK rifle. When using 5.56 mags, the potential to chamber and fire a .300 BLK round in a 5.56 rifle with catastrophic results requires diligent ammunition management by the shooter. The PMAG 30 AR 300 B's distinct rib design provides the shooter a distinct visual and tactile difference from any other PMAG to mitigate dangerous cross-loading issues. Along with optimized .300 BLK performance, the PMAG 30 AR 300 B brings along all of the GEN M3 features such as our next-generation impact and crush resistant polymer, aggressive front and rear texture, an easily removable slim floor plate, a paint pen dot matrix for marking and identification, and a dust/impact cover.

300BLK

BLK





**PMAG D-60
DRUM POUCH**

SEE PAGE 160



PMAG D-60

MAG576 | **MSRP \$129.95** | 5.56 NATO / .223 REMINGTON

The PMAG D-60 is a durable, lightweight, highly reliable 60-round 5.56x45 NATO/.223 Remington polymer drum magazine for AR15/M4 compatible weapons. With a larger capacity than previous PMAGs, the PMAG D-60 gives the shooter 60 rounds of ammunition, effectively allowing the same round count as two standard capacity 30-round magazines without requiring a critical reload. The unique drum configuration keeps the height of the magazine manageable as well, allowing prone firing and easier storage. Features a paint pen dot matrix for easy marking and a rear window for instant capacity indication. Compatible with a wide range of NATO firearms such as the M4, M16, SCAR MK16/16S, HK416, MR556, M27 IAR, and others.



5.56 x 45

BLK

PMAG 40 AR/M4 GEN M3

MAG233 | **MSRP \$19.95** | 5.56 NATO / .223 REMINGTON
NSN: 1005-01-591-8124 (BLK)

The PMAG 40 GEN M3 is a durable and reliable 40-round 5.56x45 NATO/.223 Remington polymer magazine for AR15/M4 compatible weapons. It features an over-insertion stop, stainless steel spring, four-way anti-tilt follower, constant-curve internal geometry for reliable feeding, and simple tool-less disassembly to ease cleaning. Aggressive ribs and front/rear texture give positive control in all environments, and a paint pen dot matrix on the body allows easy marking for identification. A flared floorplate aids extraction and handling of the magazine while providing improved drop protection, and is slimmer than earlier generations for better compatibility with tight magazine pouches. Also compatible with a wide range of platforms such as the HK 416, MR556A1, M27 IAR, British SA-80, FN SCAR MK 16/16S, and others.



5.56 x 45

BLK

PMAG 30 AR/M4 GEN M3 WINDOW

MAG556 | **MSRP \$17.95** | 5.56 NATO / .223 REMINGTON
NSN: 1005-01-615-5169 (BLK)

The PMAG 30 GEN M3 Window is a durable, lightweight, high reliability 30-round 5.56x45 NATO/.223 Remington polymer magazine for AR15/M4 compatible weapons with the full set of GEN M3 improvements. In addition, durable dual-side transparent windows allow for quick determination of approximate number of rounds remaining in the magazine. Utilizing a high visibility indicator coil on the spring and numerical markers on the magazine body, the MagLevel system provides positive verification without affecting the durability or reliability of the magazine. Also compatible with the HK 416 and MR556A1, M27 IAR, British SA-80, FN SCAR MK 16/16S, and others.



5.56 x 45

BLK

MCT

PMAG 30 AR/M4 GEN M3

MAG557 | **MSRP \$14.95** | 5.56 NATO / .223 REMINGTON

The PMAG 30 GEN M3 is a durable, lightweight, high reliability 30-round 5.56x45 NATO/.223 Remington polymer magazine for AR15/M4 compatible weapons. It features an over-insertion stop, long-life stainless steel spring, four-way anti-tilt follower, constant-curve internal geometry for reliable feeding, and simple tool-less disassembly. Aggressive ribs and front/rear texture give positive control in all environments, and a paint pen dot matrix on the body allows easy marking for identification. A slim, flared floorplate aids extraction and handling while providing improved drop protection and better compatibility with tight double and triple magazine pouches. Also compatible with the HK 416 and MR556A1, M27 IAR, British SA-80, FN SCAR MK 16/16S, and others.



5.56 x 45

BLK

MCT



PMAG 20 AR/M4 GEN M3

MAG560 | **MSRP \$13.95** | 5.56 NATO / .223 REMINGTON

The PMAG 20 GEN M3 brings the M3 improvements to the 20 round magazine form factor. All of the GEN M3 improvements are here, including the constant curve geometry and four-way anti-tilt, low-friction follower. This gives you the shorter length and easier manipulation in the prone of a 20 round magazine, with all the reliability and durability of the GEN M3.



PMAG 10 AR/M4 GEN M3

MAG559 | **MSRP \$13.95** | 5.56 NATO / .223 REMINGTON

The PMAG 10 GEN M3 brings GEN M3 technology to the smallest possible magazine size. Perfect for hunting applications with or without the addition of a limiter, depending on local hunting regulations, and also for states where overall capacity is limited. The 10 round GEN M3 includes all of the benefits of the GEN M3 line. Perfect for use with a bipod or when shooting off of a pack.



PMAG 30 AR/M4 GEN M2 MOE WINDOW

MAG570 | **MSRP \$15.95** | 5.56 NATO / .223 REMINGTON

The PMAG 30 GEN M2 Window (5.56 NATO/.223 Remington) is a durable, lightweight, high reliability 30-round polymer magazine optimized for the AR15/M4. Otherwise identical to the standard PMAG, the PMAG 30 MagLevel window features transparent windows on both sides of the body and has a painted indicator on the spring for quick determination of approximate rounds remaining in the magazine.



PMAG 30 AR/M4 GEN M2 MOE

MAG571 | **MSRP \$12.95** | 5.56 NATO / .223 REMINGTON

The PMAG 30 AR/M4 GEN M2 MOE is a lightweight 5.56x45 NATO (.223 Remington) AR15/M4 compatible magazine. It features advanced impact resistant polymer construction, and an easy to disassemble design with a flared floorplate for positive magazine extraction from pouches.



5.56 x 45

BLK

5.56 x 45

BLK

MOE

5.56 x 45

BLK

MOE

5.56 x 45

BLK



PMAG 25 M118 LR/SR GEN M3 WINDOW

MAG577 | **MSRP \$22.95** | 7.62 NATO / .308 WINCHESTER

The 7.62x51 (.308 Winchester) PMAG 25 M118 LR/SR GEN M3 Window is a lightweight, cost effective, high reliability magazine for SR25/M110 pattern rifles using longer than SAAMI-spec match ammunition up to 2.830" OAL. Features true 25-round capacity, constant-curve body, anti-tilt follower, snap on Impact/Dust Cover, and transparent MagLevel™ windows to allow rapid visual identification of approximate number of rounds remaining.



PMAG 25 LR/SR GEN M3 WINDOW

MAG292 | **MSRP \$22.95** | 7.62 NATO / .308 WINCHESTER

The 7.62x51 NATO (.308 Winchester) PMAG 25 LR/SR GEN M3 Window is a lightweight, cost effective, high reliability magazine for SR25/M110 pattern rifles featuring true 25-round capacity, constant-curve body, anti-tilt follower, and snap on Impact/Dust Cover. Designed specifically for SAAMI-spec ammunition, the PMAG 25 LR/SR also features transparent MagLevel™ windows to allow rapid visual identification of approximate number of rounds remaining.



PMAG 20 LR/SR GEN M3

MAG291 | **MSRP \$19.95** | 7.62 NATO / .308 WINCHESTER

The 7.62x51 NATO (.308 Winchester) PMAG 20 LR/SR GEN M3 is a lightweight, cost effective, high reliability magazine for SR25/M110 pattern rifles featuring true 20-round capacity, constant-curve body, anti-tilt follower, and snap on Impact/Dust Cover. Designed specifically for SAAMI-spec ammunition, the PMAG 20 LR/SR is less than half the weight of standard issue steel magazines and maintains a service life round count approximately equal to the rifle barrel itself.



PMAG 10 LR/SR GEN M3

MAG290 | **MSRP \$18.95** | 7.62 NATO / .308 WINCHESTER

The 7.62x51 NATO (.308 Winchester) PMAG 10 LR/SR GEN M3 is a lightweight, cost effective, high reliability magazine for SR25/M110 pattern rifles in the smallest possible magazine size. Ideal for hunting applications with the addition of our Minus Five Round Limiter, for use in states where overall capacity is limited, or with precision platforms using longer than SAAMI-spec match ammunition up to 2.830" OAL. Perfect for use with a bipod or when shooting off of a pack.



7.62 x 51

7.62 x 51

7.62 x 51

7.62 x 51

BLK

BLK

MAGPUL

MAGAZINES



PMAG 30 AK/AKM GEN M3

MAG573 | **MSRP \$26.95** | 7.62X39

The Magpul PMAG 30 AK/AKM GEN M3 is a lightweight, high reliability 30-round polymer magazine for 7.62x39 Kalashnikov pattern rifles (AK-47, AKM, AKS, SIG556R and others.) It features steel-reinforced locking lugs and front spine, removable floorplate, constant curve geometry, and a high-reliability/low-friction follower for the performance and military-grade durability you expect from a PMAG. Magazine counts as three US compliance parts for 922r.



7.62 x 39

BLK

PMAG 30 AK/AKM MOE

MAG572 | **MSRP \$13.95** | 7.62X39

The PMAG 30 AK/AKM MOE is a lightweight, high reliability 30-round polymer magazine designed for Kalashnikov pattern rifles (AK-47, AKM, AKS, SIG556R and others) in 7.62x39 mm. It features a removable floorplate, constant curve geometry, and a high-reliability/low-friction follower for the affordable performance you expect from a MOE PMAG. Magazine counts as three US compliance parts for 922r.



MOE

7.62 x 39

BLK

NEW PRODUCT

PMAG 20 AK/AKM MOE

MAG658 | **MSRP \$12.95** | 7.62X39

The Magpul PMAG 20 AK/AKM MOE is a lightweight, high reliability 20-round polymer magazine for 7.62x39 Kalashnikov pattern rifles (AK-47, AKM, AKS, SIG556R and others.) It features a removable floorplate, constant curve geometry, and a high-reliability/low-friction follower for the affordable performance you expect from a MOE PMAG. Magazine counts as three US compliance parts for 922r.



MOE

7.62 x 39

BLK

PMAG 10 AK/AKM MOE

MAG657 | **MSRP \$12.95** | 7.62X39

The Magpul PMAG 10 AK/AKM MOE is a lightweight, high reliability 10-round polymer magazine for 7.62x39 Kalashnikov pattern rifles (AK-47, AKM, AKS, SIG556R and others.) It features a removable floorplate, constant curve geometry, and a high-reliability/low-friction follower for the affordable performance you expect from a MOE PMAG. Magazine counts as three US compliance parts for 922r.



MOE

7.62 x 39

BLK



NEW PRODUCT

PMAG 30 AK74 MOE

MAG673 | **MSRP \$13.95** | 5.45X39

The Magpul PMAG 30 AK74 MOE is a lightweight, high reliability 30-round polymer magazine for 5.45x39 Kalashnikov AK-74 pattern rifles. It features a removable floorplate, constant curve geometry, and a high-reliability/low-friction follower for the affordable performance you expect from a MOE PMAG. Magazine counts as three US compliance parts for 922r.



MOE

5.45 x 39

BLK

PMAG 30 SPC GEN M3 WINDOW

MAG555 | **MSRP \$19.95** | REMINGTON 6.8 SPC

The PMAG 30 SPC GEN M3 is a durable, lightweight, high reliability 30-round 6.8 Remington SPC polymer magazine for 6.8SPC Magwell Spec weapons, including the LWRC International SIX8 platform. Shares all of the construction quality and features of the GEN M3 line. NOTE: This magazine does not fit in standard 5.56/.223 magwells.



6.8 SPC

BLK

PMAG 30 AUS GEN M3 WINDOW

MAG575 | **MSRP \$19.95** | 5.56 NATO / .223 REMINGTON

The PMAG 30 AUS GEN M3 Window is a 30-round 5.56x45 NATO polymer magazine for Steyr AUG/F88/F90 pattern weapons that features transparent windows to allow rapid identification of remaining capacity. Similar to the GEN M3 PMAG for the AR15/M4, the PMAG 30 AUS GEN M3 features a stainless steel spring, anti-tilt follower, constant-curve internal geometry for reliable feeding, and simple tool-less disassembly. In addition, low profile ribs and aggressive front and rear texture gives positive control in all environments. A paint pen dot matrix has been added to the bottom panel of the body to allow easy labeling. The GEN M3 flared floorplate aids in extraction and handling, and is slimmer than factory Steyr floorplates for better fit in magazine pouches.



5.56 x 45

BLK

PMAG 30G

MAG234 | **MSRP \$27.95** | 5.56 NATO / .223 REMINGTON

The PMAG 30G (5.56 NATO/.223 Remington) is a durable, lightweight, high reliability 30-round polymer magazine for the HK G36. The PMAG 30G features a four-way anti-tilt follower, constant-curve internal geometry, slim-line body for enhanced pouch compatibility, and MagLevel round indicator windows to easily identify loaded round count. PMAG 30G utilizes the same floor plate, lock plate, and Milspec black oxide coated stainless steel spring as the original PMAG 30 to ensure durability and performance in all environments.



5.56 x 45

BLK

MAGAZINES COMPARISON



	PMAG D-60	PMAG 40 AR/M4 GEN M3	PMAG 30 AR/M4 GEN M3	PMAG 30 AR/M4 GEN M3 W	PMAG 20 AR/M4 GEN M3	PMAG 10 AR/M4 GEN M3	MOE PMAG 30 AR/M4 GEN M2	MOE PMAG 30 AR/M4 GEN M2 W	PMAG 30 AK/AKM GEN M3	MOE PMAG 30 AK/AKM		MOE PMAG 20 AK/AKM	MOE PMAG 10 AK/AKM	MOE PMAG 30 AK74	PMAG 30 SPC GEN M3 W	PMAG 30 AR 300 B GEN M3	PMAG 25 M118 LR/SR	PMAG 25 LR/SR GEN M3	PMAG 20 LR/SR GEN M3	PMAG 10 LR/SR GEN M3	PMAG 30 AUS GEN M3 W	PMAG 30G	
SKU	MAG576	MAG233	MAG557	MAG556	MAG560	MAG559	MAG571	MAG570	MAG573	MAG572		MAG658	MAG657	MAG673	MAG555	MAG800	MAG577	MAG292	MAG291	MAG290	MAG575	MAG234	
MSRP	\$129.95	\$19.95	\$14.95	\$17.95	\$13.95	\$13.95	\$12.95	\$15.95	\$26.95	\$13.95		\$12.95	\$12.95	\$13.95	\$19.95	\$15.95	\$22.95	\$22.95	\$19.95	\$18.95	\$19.95	\$27.95	
WEAPON	AR15 - M4 HK 416 SA80 - SCAR 16	AR15 - M4 HK 416 SA80 - SCAR 16	AR15 - M4 HK 416 SA80 - SCAR 16	AR15 - M4 HK 416 SA80 - SCAR 16	AR15 - M4 HK 416 SA80 - SCAR 16	AR15 - M4 HK 416 SA80 - SCAR 16	AR15 - M4 HK 416 SA80 - SCAR 16	AR15 - M4	AR15 - M4	AK/AKM	AK/AKM		AK/AKM	AK/AKM	AK74	LWRC SIX8	AR15 - M4 SIG MCX (300BLK)	SR25 - M110	SR25 - M110	SR25 - M110	SR25 - M110	STEYR AUG/F88/F90	HK G36
CALIBER	5.56/.223	5.56/.223	5.56/.223	5.56/.223	5.56/.223	5.56/.223	5.56/.223	5.56/.223	7.62X39	7.62X39		7.62X39	7.62X39	5.45X39	6.8X43/6.8 SPC	7.62X35/300BLK	7.62X51/.308	7.62X51/.308	7.62X51/.308	7.62X51/.308	5.56/.223	5.56/.223	
ROUNDS	60	40	30	30	20	10	30	30	30	30		20	10	30	30	30	25	25	20	10	30	30	
COLORS	BLK	BLK	BLK - MCT	BLK - MCT	BLK	BLK	BLK	BLK	BLK	BLK		BLK	BLK	BLK	BLK	BLK	BLK	BLK	BLK	BLK	BLK	BLK	
GENERATION	M3	M3	M3	M3	M3	M3	M2	M2	M3	M3		M3	M3	M3	M3	M3	M3	M3	M3	M3	M3	M2	
MARKING GRID	■	■	■	■	■				■	■		■	■	■	■	■	■	■	■	■		■	
WINDOW	■			■				■							■		■	■			■	■	



MAGPUL

PMAG FLOOR PLATES

5-PACK

- MAG688 | **MSRP \$9.95** | PMAG GL9 MAGAZINES
- MAG684 | **MSRP \$9.95** | AR/M4 GEN M3 MAGAZINES
- MAG686 | **MSRP \$11.95** | LR/SR GEN M3 MAGAZINES
- MAG689 | **MSRP \$10.95** | AK/AKM MAGAZINES

Utilizing Magpul's unique Sand material, separate PMAG Floor Plates are available in 5-packs to allow for customizable marking and identification. The Sand PMAG Floor Plate can be utilized as is, or dyed to nearly any color using readily available commercial dyes.



NEW PRODUCT

SND

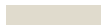

ORIGINAL MAGPUL

3-PACK

- MAG001 | **MSRP \$9.95** | 5.56 NATO MAGAZINES
- MAG002 | **MSRP \$9.95** | 7.62 NATO MAGAZINES
- MAG003 | **MSRP \$9.95** | 9MM/SMG MAGAZINES
- NSN# 9MM: 1005-01-554-2864 (MAG003-BLK)
- NSN# 5.56MM: 1005-01-554-2868 (MAG001-BLK)

The original Magpul rubberized loop attaches to the bottom of the magazine to increase controllability and speed during high-stress tactical magazine changes. The original Magpul is based on the tried and true paracord loops and duct tape tabs originally used by special warfare units worldwide. Fits most aluminum, steel, and polymer magazines including the Magpul PMAG.



BLK

FDE

ODG



MAGAZINE ACCESSORIES



MAGLINK AR/M4 & AK/AKM

MAG566 | **MSRP \$17.95** | PMAG 30 AK/AKM, PMAG 30 AK/AKM GEN M3 [ALL 7.62X39 VERSIONS]
 MAG595 | **MSRP \$17.95** | PMAG 30 GEN M2, PMAG 30/40 GEN M3 [ALL 5.56 VERSIONS]

The MagLink is a coupler for AR/M4 and AK/AKM PMAGs in both GEN M2 MOE and GEN M3s that have a capacity of 30 or 40 rounds. The MagLink allows the user to attach two magazines together for more efficient speed reloads, and to keep an additional 30 or 40 rounds of ammunition accessible on the weapon at all times. The MagLink features a two-piece bolt on design, and durable, lightweight reinforced polymer construction.

Note: the MagLink is not compatible with the first generation PMAG 30, PMAG 20, EMAG, PMAG 30G, or LR/SRPMAGS.

PMAG AK/AKM



PMAG AR/M4



BLK



RANGER PLATE

3-PACK

MAG561 | **MSRP \$14.95** | ALL AR/M4 GEN M3 PMAGS
 MAG564 | **MSRP \$14.95** | ALL LR/SR GEN M3 PMAGS
 MAG212 | **MSRP \$14.95** | ALL AR/M4 GEN M2 PMAGS
 MAG020 | **MSRP \$19.95** | ALUMINUM USGI 30 ROUND MAGS
 MAG565 | **MSRP \$19.95** | ALL AK/AKM PMAG 30

The PMAG Ranger Plate brings the speed and controllability of the original Magpul to the Magpul PMAG system. The reinforced polymer base has an overmolded rubber loop that provides positive control and impact protection. The PMAG Ranger replaces standard PMAG floor plates and features a para-cord hole for custom loop configurations. The overmolded Ranger Plate for USGI replaces the standard floor plate on USGI 30-round 5.56 NATO aluminum magazines.

AK/AKM PMAG 30



BLK



PMAG ROUND LIMITERS

3-PACK

MAG285 | **MSRP \$13.95** | -5 ROUND FOR GEN M3 AR/M4 PMAGS
 MAG286 | **MSRP \$13.95** | -10 ROUND FOR GEN M3 AR/M4 PMAGS
 MAG562 | **MSRP \$13.95** | -5 ROUND FOR GEN M3 LR/SR PMAGS
 MAG563 | **MSRP \$13.95** | -10 ROUND FOR GEN M3 LR/SR PMAGS

The PMAG Round Limiters install in 10, 20, or 30 round GEN M3 magazines, reducing the magazine capacity by 5 or 10 rounds. Designed for sporting and hunting applications, installation of the Limiter is simple, tool-less, and requires no permanent modification of the magazine body.

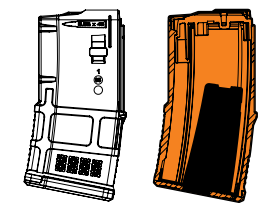

BLK



USGI L-PLATE

3-PACK

MAG024 | **MSRP \$19.95** | ALUMINUM USGI 30 ROUND

The low profile overmolded L-Plate replaces the standard floor plate on USGI 30-round 5.56 NATO aluminum magazines, aiding in magazine control and acting as an impact bumper to shield the magazine against damage when dropped.

USGI ENHANCED SELF-LEVELING FOLLOWER

3-PACK

MAG110 | **MSRP \$5.95** | ALUMINUM USGI 30 ROUND

The Magpul Enhanced Self-Leveling Follower is a drop-in replacement for the issued green or black USGI 30-round magazine followers. The 4-way anti-tilt design increases weapon reliability by eliminating many common magazine-related malfunctions. Followers are made from self-lubricating non-hygroscopic resin.



DUMMY ROUNDS

5-PACK

MAG215 | **MSRP \$4.95** | 5.56 NATO / .223 REMINGTON
NSN: 1310-01-591-5927(MAG215)

Five dimensionally correct, solid, dummy rounds made from our proprietary hard polymer. Used for test feeding of magazines or other training, these can be cycled and ejected using the rifle action.

SPEEDPLATE

3-PACK

MAG230 | **MSRP \$14.95** | .40 & 9MM GLOCK MAGZINES
NSN: 1005-01-591-6113

The SpeedPlate is designed for factory Glock 9mm and .40 caliber magazines. When attached to the base of the magazine the SpeedPlate can improve speed reloads and assist in fully seating the magazine.



BLK | FDE | ODG



FOL | YEL



BLK



BLK



BOLT ACTION

PRECISION RIFLE PERFORMANCE WITH A HUNTING HERITAGE.

The Hunter stock is a problem solver. The problem, "Why do I have to choose performance over affordability?", had no solution until the Hunter 700 stock. Entry-level stocks generally lacked adjustability and rigidity. Chassis systems without those limitations were rather expensive. Our goal was to give the bolt-action rifleman a lightweight stock with better fit, solid bedding and advanced features at an attractive price point, with options for short and long-action users. Capitalizing on the already proven design of the SGA, the Magpul Hunter 700 and Hunter 700 LA offer fast and easy adjustments of both length of pull and comb height with an intuitive interface. It has QD cup capability, advanced ergonomic features, and accepts all M-LOK compatible accessories. The stock works out of the box with Remington OEM bottom metal, but if you want to add a detachable magazine, simply remove the bottom metal and add our Bolt Action Magazine Well, which takes about five minutes and requires no custom inletting.

If we don't make a Hunter stock for your rifle yet, stay tuned.





HUNTER 700L STOCK

MAG483 | **MSRP \$279.95** | REMINGTON 700 LONG ACTION RIFLES

Made from reinforced polymer and a machine finished, anodized A380 cast aluminum bedding block, the Magpul Hunter 700L stock offers users a fully adjustable length of pull, comb height, and enhanced ergonomics. Compatible with all Remington 700 Long Actions, this stock requires no bedding and is a true "drop-in" solution for the end user. This stock is M-LOK compatible to accept a broad range of accessories. Also available is our Bolt Action Magazine Well 700L, which allows the rifle to be used with detachable box magazines without the need for custom inletting.



HUNTER-SGA CHEEK RISER KITS

SEE PAGE 059



BLK | FDE | ODG | GRY

BOLT ACTION MAGAZINE WELL 700L, STANDARD

NEW PRODUCT

MAG489 | **MSRP \$79.95** | HUNTER 700L STOCK

The Magpul Bolt Action Magazine Well 700L, Standard is a drop-in detachable box magazine solution for our Hunter 700L Stock. By simply removing your OEM bottom metal from the Hunter 700L, users can add this reinforced polymer trigger guard and magazine well without the need for custom inletting. Designed to work with AICS-pattern long action magazines, this kit also includes one Magpul PMAG 5 AC L, Standard for .30-06 based family of cartridges.

PMAG 5 AC L, STANDARD

NEW PRODUCT

MAG671 | **MSRP \$39.95** | AICS LONG ACTION

The PMAG 5 AC L, Standard is a reliable and durable polymer magazine for .30-06 based family of cartridges and is compatible with long action AICS-spec bottom metal, to include the Bolt Action Magazine Well 700L for the Hunter 700L Stock. Built using M3 technology, this magazine is advanced in both material and manufacturing processes providing an economical, lightweight, durable and reliable single-stack bolt action magazine. It comes standard as a 5-round capacity magazine for hunting regulation compliance, but the follower can be easily modified by the user to increase the capacity to six rounds for field, competition, or combat use

BLK

BOLT ACTION MAGAZINE WELL 700L, MAGNUM

NEW PRODUCT

MAG569 | **MSRP \$79.95** | HUNTER 700L STOCK

The Magpul Bolt Action Magazine Well 700L, Magnum is a drop-in detachable box magazine solution for our Hunter 700L Stock. By simply removing your OEM bottom metal from the Hunter 700L, users can add this reinforced polymer trigger guard and magazine well without the need for custom inletting. Designed to work with AICS-pattern long action magazines, this kit also includes one Magpul PMAG 5 AC L, Magnum for .300WM based family of cartridges.

PMAG 5 AC L, MAGNUM

NEW PRODUCT

MAG698 | **MSRP \$39.95** | AICS LONG ACTION

The PMAG 5 AC L, Magnum is a reliable and durable polymer magazine for .300 Winchester Magnum based family of cartridges and is compatible with long action AICS-spec bottom metal, to include the Bolt Action Magazine Well 700L for the Hunter 700L Stock. Built using M3 technology, this magazine is advanced in both material and manufacturing processes providing an economical, lightweight, durable and reliable single-stack bolt action magazine.

BLK





HUNTER 700 STOCK

MAG495 | **MSRP \$259.95** | REMINGTON 700 SHORT ACTION RIFLES

Made from reinforced polymer and a machine finished, anodized A380 cast aluminum bedding block, the Magpul Hunter 700 Stock offers users a fully adjustable length of pull, comb height, and enhanced ergonomics. Compatible with all Remington 700 Short Actions, this stock requires no bedding and is a true "drop-in" solution for the end user. This stock is also M-LOK compatible to accept a broad range of accessories. Also available is our Bolt Action Magazine Well, which allows the rifle to be used with detachable box magazines without the need for custom inletting.



BLK | FDE | ODG | GRY

HUNTER-SGA CHEEK RISER KITS

SEE PAGE 059



BEDDING BLOCK

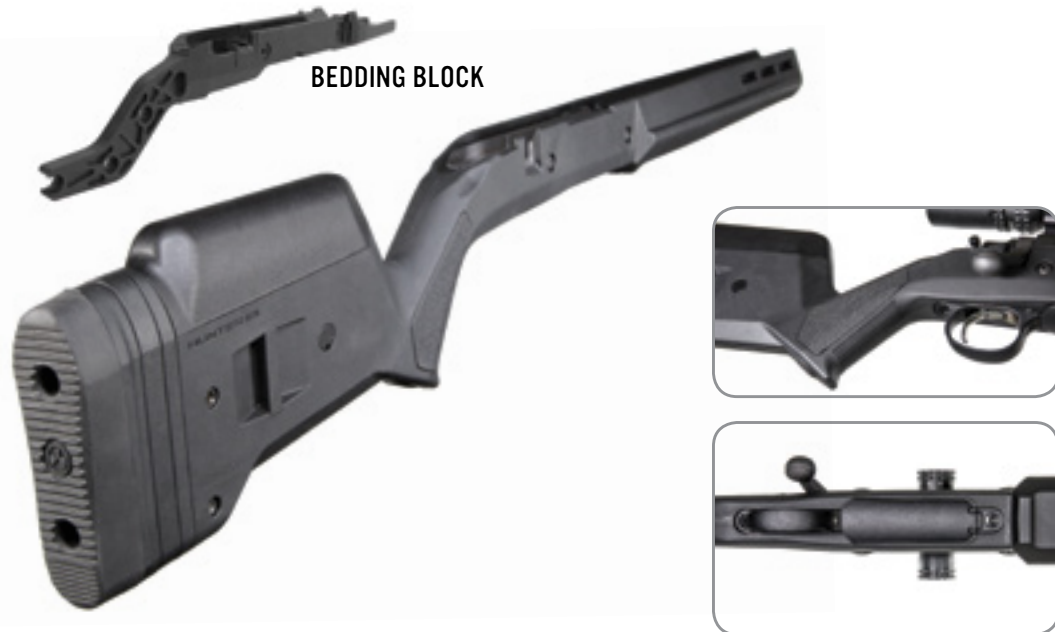

BOLT ACTION MAGAZINE WELL

MAG497 | **MSRP \$69.95** | HUNTER 700 STOCKS

The Magpul Bolt Action Magazine Well is a drop-in solution for our Magpul Hunter 700 Stock for those that are wishing to add detachable box magazine capabilities to their rifle. By simply removing your OEM bottom metal and the insert on the Hunter 700 Stock, users can add this reinforced polymer trigger guard and magazine well to their rifle without the need for custom inletting from gunsmiths. Designed to work with AICS pattern, short action magazines. This kit also includes one Magpul PMAG 5 7.62 AC.



PMAG 5 7.62 AC

MAG549 | **MSRP \$34.95** | 7.62X51 / .308 WINCHESTER

The PMAG 5 7.62 AC is a reliable and durable polymer magazine compatible with AICS spec bottom metal. It comes standard as a 5 round capacity magazine for hunting regulation compliance, but the follower can be easily modified by the user to increase the capacity of the magazine to 6 for field, competition or combat use. Built using M3 technology, this magazine is advanced in both material technology and manufacturing processes, and we've given it more features to make it the most advanced, reliable bolt action magazine on the market.



BLK

PMAG 10 7.62 AC

MAG579 | **MSRP \$39.95** | 7.62X51 / .308 WINCHESTER

The PMAG 10 7.62 AC is a reliable and durable 7.62x51/.308 Winchester polymer magazine compatible with short-action AICS spec bottom metal. Built using Magpul's latest M3 technology, this magazine is designed for use with short action cartridges built on a .470" case head and features a 10 round capacity.



BLK



RIMFIRE

EXTENDING PREMIUM FEATURES TO THE RIMFIRE PLATFORM.

Capitalizing on the design and performance of the Hunter 700, the Hunter X-22 and Hunter X-22 Takedown followed suit, bringing the performance of a modular stock with customizable fit to the Ruger 10-22 and 10/22 Takedown series.

New for 2017, the Hunter X-22 Backpacker takes the proven feature set of the Hunter X-22 Takedown and pares it down to an easily transportable package suitable for all your travel needs.





NEW PRODUCT

X-22 BACKPACKER STOCK

MAG808 | MSRP \$109.95 | RUGER 10/22 TAKEDOWN RIFLES

The Magpul X-22 Backpacker stock takes the function of our full-size Hunter X-22 Takedown, and pares it down for ease of storage and transportation. Made for the Ruger 10/22 Takedown rifle, the X-22 Backpacker offers a minimalist solution for the hunter or outdoorsman who wants to transport their rifle in an efficient, convenient package without compromising shooting performance. Constructed of a durable advanced polymer, the Hunter X-22 Backpacker features an ergonomic hand guard, optional QD sling mounting capability, integrated storage compartment in the grip, a hinged storage compartment in the stock capable of storing up to 3 spare 10rd magazines, a MOE SL non-slip rubber butt pad, and a unique locking interface to attach the barrel assembly to the receiver when being transported. Fits all Ruger 10/22 Takedown rifles as well as the Tactical Solutions SBX barrel.



NEW
PRODUCT

HUNTER X-22 TAKEDOWN STOCK

MAG760 | **MSRP \$149.95** | RUGER 10/22 TAKEDOWN RIFLES

The Magpul Hunter X-22 Takedown chassis is an ergonomic, full-featured stock specifically designed for the Ruger 10/22 Takedown series of rifles. Made from high quality reinforced polymer, the Hunter X-22 Takedown features an ergonomic grip, adjustable length of pull and comb height to fit a wide variety of shooters, multiple sling mounting options, a non-slip rubber butt-pad, and M-LOK slots for accessory attachment. The Hunter X-22 Takedown fits standard Ruger 10/22 Takedown .22 LR pattern rifles with no gunsmithing, and a reversible barrel tray ensures proper fit with factory pencil profile as well as heavy bull barrels.



BLK | FDE | ODG | GRY

HUNTER X-22 STOCK

MAG548 | **MSRP \$139.95** | RUGER 10/22 RIFLES

The Magpul Hunter X-22 chassis is an ergonomic, full-featured stock for the ubiquitous Ruger 10/22 rifle. Made from high quality reinforced polymer, the Hunter X-22 features an ergonomic grip, adjustable length of pull and comb height to fit a wide variety of shooters, multiple sling mounting options, a non-slip rubber butt-pad, and M-LOK slots for accessory attachment. The Hunter X-22 fits standard Ruger 10/22 .22 LR pattern rifles with no gunsmithing, and a reversible barrel tray ensures proper fit with factory pencil profile as well as heavy bull barrels.



BLK | FDE | ODG | GRY | PNK

HUNTER-SGA CHEEK RISER KITS
SEE PAGE 059



EVERYWHERE: 

EVERYWHERE: BACKCOUNTRY



KALASHNIKOV

UNCLE SAM MEETS MOTHER RUSSIA.

Using typical Magpul design, engineering, and production quality, full Magpul support for the AK platform has arrived. Not satisfied with adapting AR products to the AK, nor with trying to turn the AK into an AR, we started from scratch in developing our new full line of furniture for Kalashnikov platforms. The Magpul AK line encompasses the needs of recreational and professional users with a combination of functionality and value developed for the unique attributes of this family of firearms. Magpul styling and modern functionality meet with a few nods to tradition in creating products that work with existing optics mounting solutions, provide M-LOK accessory mounting, and have the durability to match the rifle itself. Our commitment to the Kalashnikov platform continues to grow as witnessed with the additional of two additional grips and an additional hand guard. In 2017, we will continue to expand our AK product line which will continue to provide the end user with ways to customize the Kalashnikov platform.



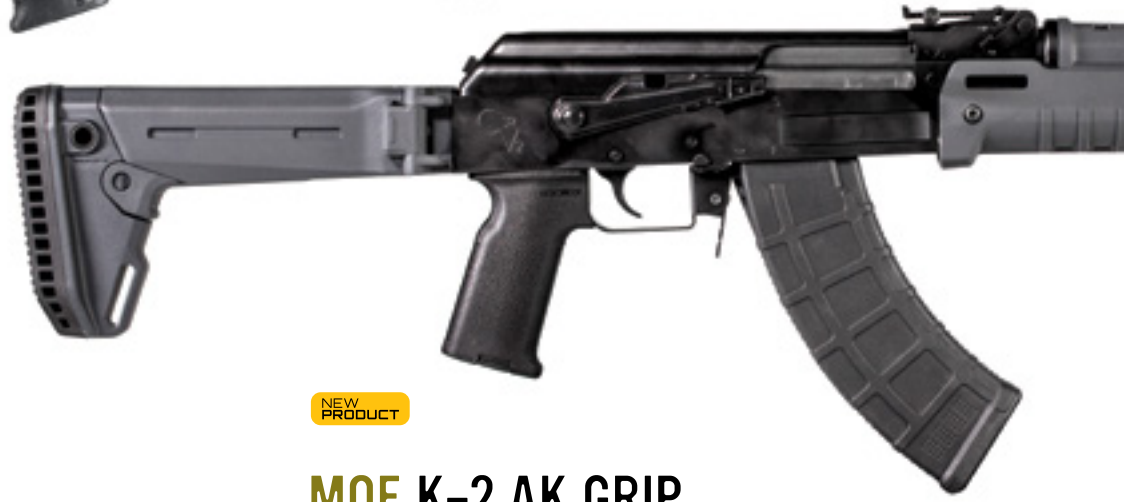

NEW PRODUCT

ZHUKOV-U HAND GUARD

MAG680 | MSRP \$99.95 | AK-47/AK-74

Much like its predecessor Zhukov hand guard, the Magpul Zhukov-U Hand Guard is a fully-featured AK forearm for the modern AK. Optimized for short barrel rifles, the Zhukov-U Hand Guard is 1.5" shorter than the standard Zhukov Hand Guard and is compatible with rifles with standard-length gas systems. It casts aside traditional AK forearm shortcomings and offers an extended option for modern shooting techniques, an aluminum chassis for strength and heat dispersion, featuring a relief cut to accept a standard AK cleaning rod, a comfortable injection molded exterior for superior ergonomics, and M-LOK slots for optimized accessory attachment. Compatible with the Ultimak gas tube rail for optics mounting, the Zhukov-U Hand Guard redefines functionality for the modern AK platform. Installation requires permanent removal of the hand guard retainer.



NEW PRODUCT

MOE SL AK GRIP

MAG682 | MSRP \$19.95 | AK-47/AK-74

The MOE SL AK Grip (MOE Slim Line) is a drop-in upgrade for AK47/AK74 pistol grips with a more vertical angle optimized for these shorter LOP weapons that bring the primary hand in closer to the shooter's body. With an aggressive TSP texture for positive weapon control along with modern ergonomics, the MOE SL AK Grip provides a slightly smaller size and slimline feel compared to our full size grips.



MOE



NEW PRODUCT

MOE K-2 AK GRIP

MAG683 | MSRP \$20.95 | AK-47/AK-74

Similar to the MOE SL, the MOE-K2 AK Grip is a drop-in upgrade for AK47/AK74 platforms that offers a more vertical grip angle, but in a full-size grip design. The steeper vertical grip angle improves comfort and control on these shorter LOP rifles that bring the primary hand in closer to the shooter's body. With an aggressive TSP texture for positive weapon control, compatibility with optional Storage Cores for gear stowage, and a unique backstrap design for proper trigger finger placement, the K2 brings modern styling and ergonomics to the AK platform.



MOE





ZHUKOV-S STOCK

MAG585 | **MSRP \$99.95** | AK-47/AK-74

The Magpul Zhukov-S Stock is a no-compromise folding stock for the modern AK. The Zhukov-S Stock casts aside traditional AK stock shortcomings and offers a folding, collapsible stock with QD sling mounts, modular Cheek Risers, and a shock-absorbing rubber butt-pad for superior traction. The Zhukov-S has right-side folding for compatibility with side-mounted optics. Designed to fit most common stamped AK receivers without modification via a unique wedge block, the durable injection molded polymer Zhukov-S Stock redefines the human interface with the AK platform.

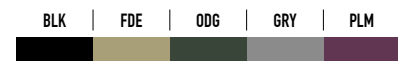

ZHUKOV-S STOCK YUGO

MAG552 | **MSRP \$99.95** | AK-47/AKM/AK-74

The YUGO Zhukov-S hinge block for fixed-stock Yugoslavian pattern rifles allows the user to replace their factory buttstock with a high quality folding polymer buttstock. The hinge block mounts directly to the unique rear interface of Yugo pattern rifles with the included hardware providing a very robust fit. The Zhukov-S Stock folds to the right, has adjustable comb height for optics use via optional cheek risers, is adjustable for length-of-pull without tools, and features an angled rubber butt-pad for easy shoulder transition and slip-free performance. An included one-point QD mount at the receiver, optional QD mounting points at the rear of the stock provides multiple sling attachment options.



MOE AK STOCK

MAG616 | **MSRP \$59.95** | AK-47/AK-74

Providing Magpul construction and ingenuity to the venerable AK platform, the Magpul MOE AK Stock is an optimized fixed stock for most stamped-receiver rifles. Featuring the unique wedge block fitment of the Zhukov-S Stock, the MOE AK Stock provides internal storage, optimized QD sling swivel placement, a shock absorbing rubber butt-pad for positive placement, and user-selectable snap on Cheek Risers. (Sold Separately)

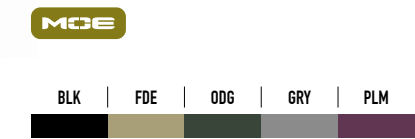



ZHUKOV HAND GUARD

MAG586 | **MSRP \$99.95** | AK-47/AK-74

The Magpul Zhukov Hand Guard is a fully-featured AK forearm for the modern AK. The Zhukov Hand Guard casts aside traditional AK forearm shortcomings and offers an extended option for modern shooting techniques, an aluminum chassis for strength and heat dispersion, a comfortable injection molded exterior for superior ergonomics, and M-LOK slots for optimized accessory attachment. Compatible with the Ultimac gas tube rail for optics mounting, the Zhukov Hand Guard redefines functionality for the modern AK platform. Installation requires removal of the hand guard retainer.

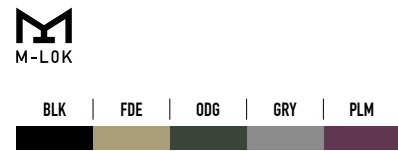

MOE AK HAND GUARD

MAG619 | **MSRP \$36.95** | AK-47/AK-74

The Magpul MOEAK Hand Guard is a replacement for standard AK pattern rifles without a front sling loop on the hand guard retainer. Featuring an extended gripping portion, integrated heat shield, M-LOK mounting capability, and replacement gas tube cover, the MOE AK Hand Guard is an upgrade to any AK pattern rifle.



MOE AKM HAND GUARD

MAG620 | **MSRP \$36.95** | AK-47/AK-74

The Magpul MOE AKM Hand Guard is a replacement for standard AKM pattern rifles that preserves function of the hand guard retainer sling loop. Featuring an extended gripping portion, integrated heat shield, M-LOK mounting capability, and replacement gas tube cover, the MOE AKM Hand Guard is an upgrade to any AK pattern rifle.





MOE AK GRIP

MAG523 | **MSRP \$20.95** | AK-47/AK-74

An upgrade for AK-pattern pistol grips, the MOE AK Grip is designed to improve ergonomics and comes with an aggressive texture for positive weapon control. With a one-piece reinforced polymer construction and compatibility with Magpul Grip Cores for storage customization, this MOE grip provides a welcome addition to the iconic AK platform. The MOE AK Grip is compatible with reinforced and unreinforced stamped receivers, and all milled receivers.



MOE

BLK | FDE | ODG | GRY | PLM



MOE AK+ GRIP

MAG537 | **MSRP \$24.95** | AK-47/AK-74

An upgrade for AK-pattern pistol grips, the MOE AK+ is compatible with reinforced and unreinforced stamped receivers. Designed to improve ergonomics and weapon control, the MOE borrows the rubber over-molded surface of the popular MOE+ AR15/M4 Grip to ensure a positive and comfortable hold on the weapon. It is compatible with Magpul Grip Cores for storage customization.



MOE

BLK | FDE | ODG | GRY



AK CHEEK RISERS

MAG445 | **MSRP \$9.95** | LOW .25"

MAG446 | **MSRP \$9.95** | MEDIUM .50"

MAG447 | **MSRP \$9.95** | HIGH .75"

Tool-less clip-on cheek risers for the MOE AK and Zhukov-S Stocks. Gives the user the option to raise the cheek weld .25, .50, or .75 inch in height. Will not interfere with storage access on MOE Stock or the folding mechanism on the Zhukov-S Stock.



BLK | FDE | ODG | GRY | PLM



AK

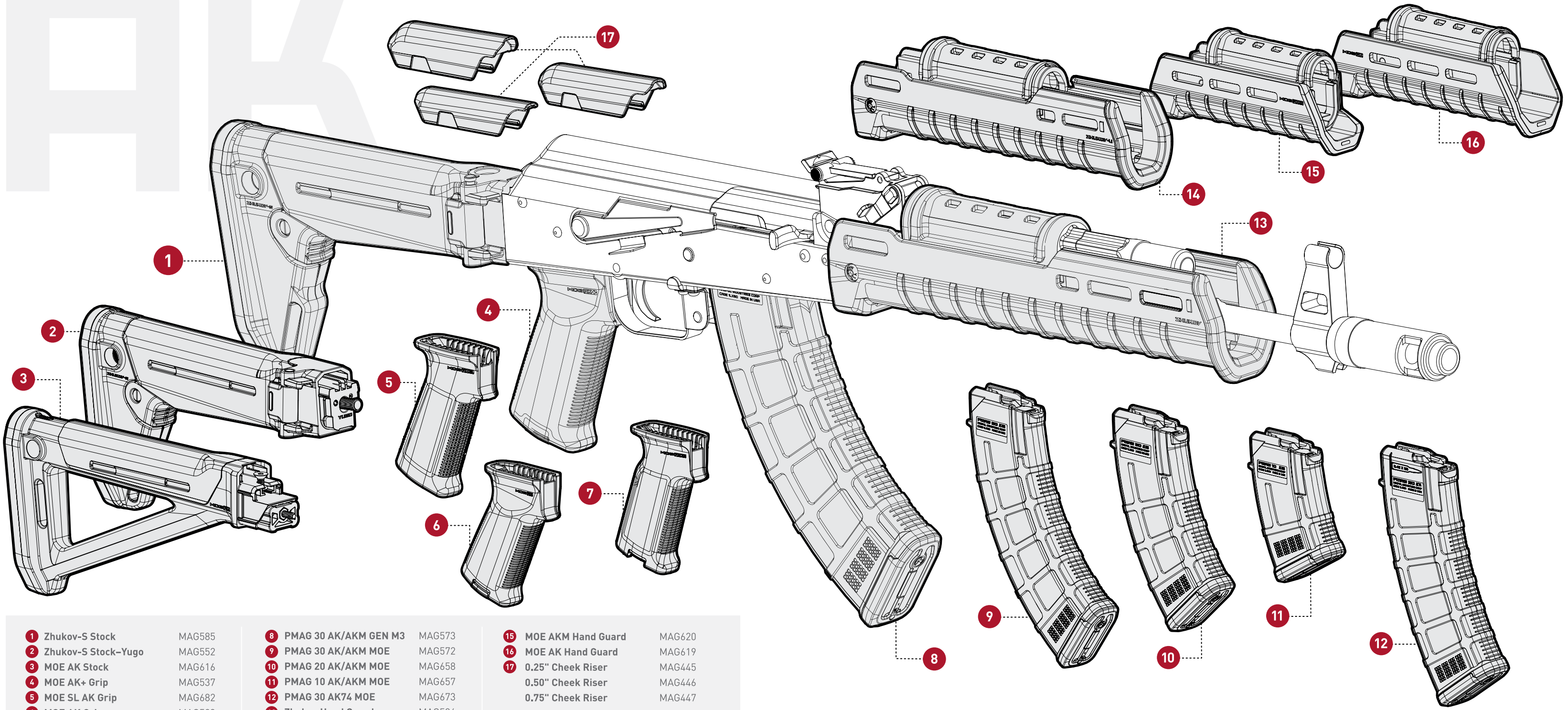

- 1 Zhukov-S Stock MAG585
- 2 Zhukov-S Stock-Yugo MAG552
- 3 MOE AK Stock MAG616
- 4 MOE AK+ Grip MAG537
- 5 MOE SL AK Grip MAG682
- 6 MOE AK Grip MAG523
- 7 MOE-K2 AK Grip MAG683

- 8 PMAG 30 AK/AKM GEN M3 MAG573
- 9 PMAG 30 AK/AKM MOE MAG572
- 10 PMAG 20 AK/AKM MOE MAG658
- 11 PMAG 10 AK/AKM MOE MAG657
- 12 PMAG 30 AK74 MOE MAG673
- 13 Zhukov Hand Guard MAG586
- 14 Zhukov-U Hand Guard MAG680

- 15 MOE AKM Hand Guard MAG620
- 16 MOE AK Hand Guard MAG619
- 17 0.25" Cheek Riser MAG445
- 0.50" Cheek Riser MAG446
- 0.75" Cheek Riser MAG447

SHOTGUN

INNOVATIVE SHOTGUN ACCESSORIES WHICH COMPLEMENT AND ENHANCE PROVEN PLATFORMS.

The SGA line of stocks and MOE M-LOK Forends for the Remington 870 and Mossberg 500/590 12 gauge pump action shotguns dispenses with convention in favor of function. The more vertical grip angle provides superior ergonomics for shotgun manipulations and handling while preserving the “pointability” that enhances shotgun effectiveness. Additionally, the adjustable length of pull and available extended height cheek risers allows you to fit your shotgun to your frame and to your sighting or optics requirements while retaining the rugged durability needed for professional employment or a hard season afield. The MOE M-LOK Forends add modularity to the proven Remington and Mossberg shotgun platforms for sporting use, home defense, or duty use.



REMINGTON 870



MOSSBERG 590A1

MOE M-LOK SHOTGUN FORENDS

MAG494 | **MSRP \$29.95** | MOSSBERG 590/590A1 12GAMAG496 | **MSRP \$29.95** | REMINGTON 870 12GA

The MOE M-LOK Forends are replacement forends for the Mossberg 590/590A1 and Remington 870 12 gauge shotguns, featuring an extended length and front/rear hand stops for improved weapon manipulations. Now featuring M-LOK slots, they are compatible with all M-LOK accessories. This adds modularity to the proven Mossberg platform for sporting use, home defense or duty use.

- Compatible with Mossberg 590/590A1 and Remington 870 12ga shotguns
- Reinforced polymer construction
- Increased length for improved pump manipulation
- Does not overlap receiver for side saddle compatibility
- M-LOK slots for direct attachment of accessories
- Installation wrench included



MOE

M-LOK

12 GAUGE

BLK

FDE

GRY

ORG

SGA SHOTGUN STOCK

MAG490 | **MSRP \$109.95** | MOSSBERG 500/590/590A1 12GAMAG460 | **MSRP \$109.95** | REMINGTON 870 12GA

The SGA Shotgun Stocks are an adaptable stock for Remington 870 and Mossberg 500/590/590A1 12 gauge shotguns, designed with a wide range of customizable features and accessories to meet individual end user needs.

- Spacer-adjustable LOP in 1/2" increments from 12.5" to 14.5"
- Recoil reducing butt-pad
- Integral right/left 1.25" sling loops
- Reinforced polymer construction
- Enhanced grip angle ergonomics
- Available butt-pad adapter for compatibility with many standard 870 recoil pads
- Available interchangeable cheek pieces for comb height adjustment
- Available left/right side QD sling attachment points



MOE

12 GAUGE

BLK

FDE

GRY

ORG



FORWARD SLING MOUNT

MAG508 | **MSRP \$29.95** | REMINGTON 870, MOSSBERG 500/590 12GA
 MAG493 | **MSRP \$29.95** | MOSSBERG 590A1 12GA

The Forward Sling Mount is a sling attachment point that clamps onto the barrel and extended magazine tube. It can be configured for use with either push-button QD sling swivels or one-point clip-in style attachments such as the Paraclip, HK hook, ITW MASH hook, and others. Made from precision cast steel that is Melonite treated for wear and corrosion resistance.



SGA RECEIVER SLING MOUNT

MAG507 | **MSRP \$19.95** | REMINGTON 870 SGA STOCK
 MAG492 | **MSRP \$19.95** | MOSSBERG 500/590/590A1 SGA STOCK

The SGA Receiver Sling Mount is an attachment point for clip-in style slings such as the MS3, HK hook, or MASH Hook. The mount is precision cast steel that is Melonite treated for wear and corrosion resistance. User-configurable for left or right side attachment with the Magpul SGA 870 and SGA 590 buttstocks.



SGA OEM BUTT-PAD ADAPTER

MAG318 | **MSRP \$9.95**

The SGA OEM Butt-Pad Adapter allows the user to replace the standard Magpul SGA Recoil Pad with a synthetic Remington-pattern or aftermarket 870 butt-pad of their choice (not included).



HUNTER-SGA CHEEK RISER KITS

MAG461 | **MSRP \$15.95** | HIGH RISE KIT - .50" & .75"
 MAG463 | **MSRP \$15.95** | LOW RISE KIT - .25" & .50"

Compatible with the Magpul SGA Shotgun Stocks, Hunter 700 and X-22 Chassis, the Hunter-SGA Cheek Riser Kits allow the user to configure their shotgun or rifle with the ideal cheek piece height to accommodate a wide range of sight/optic configurations and shooter preferences. The Riser Kits are available in two configurations: Hunter-SGA Low Rise Kit, including one (1) 0.25" cheek riser and one (1) 0.50" cheek riser, and the Hunter-SGA High Rise Kit, including one (1) 0.50" cheek riser and (1) 0.75" cheek riser. Optimal cheek piece height will vary based on sight/mount type and user preference, but common configurations include:

- Low-profile bead sights: 0.00"– 0.25" riser
- Ghost ring or other raised sights: 0.00"– 0.25" riser
- Low-profile optic (i.e. mini red dot): 0.25"– 0.50" riser*
- Standard optic (i.e. red dot or holographic sight): 0.25"– 0.50" riser*
- Magnified optic: 0.50"– 0.75" riser*



*NOTE: Add approximately 0.25" to these recommendations for aftermarket raised receiver rails and optics utilizing higher mounts. Optic mounts designed for the AR15/M4 platform may be too high for use with the SGA, Hunter 700 and X-22 depending on shooter preference.



HANDGUN

MAGPUL IS NO STRANGER TO THE HANDGUN.

Beginning in 2006 with the Glock SpeedPlate, continuing with the training provided by Magpul CORE, and creation of the MOE 1911 Grip Panels, handguns have always been a part of Magpul. With the 2015 introduction of the PMAG 17 GL9 and PMAG 15 GL9 for full-size and compact Glock handguns, a new era of handgun focus began at Magpul. 2017 will see it carried further, with new magazines and accessories built to maximize performance of both the gun and the user. Every double-stack Glock 9mm handgun will have a dedicated PMAG, with more to come this year.





NEW PRODUCT

PMAG 12 GL9

MAG674 | **MSRP \$15.95** | 9X19MM

Adding capacity and control with a minimal footprint, the PMAG 12 GL9 is a 12-round magazine for the Glock 26. Building on the proven PMAG 17 GL9 and PMAG 15 GL9, subcompact Glock users gain two more rounds of capacity while adding a built-in finger groove for a full grip. Featuring grasping grooves for easy retrieval and an easily removable floor plate with paint-pen marking matrix, the PMAG 12 GL9 brings duty capacity to subcompact convenience.



9 x 19

BLK

NEW PRODUCT

PMAG 21 GL9

MAG661 | **MSRP \$19.95** | 9X19MM

The PMAG 21 GL9 is a 21-round Glock 9mm handgun magazine featuring a new proprietary all-polymer construction for flawless reliability and durability over thousands of rounds. Meeting the overall length requirements for a 140MM competition magazine, the PMAG 21 GL9 offers additional capacity without the need for expensive extensions. High visibility controlled-tilt follower, stainless steel spring, easily removable floorplate for cleaning, paint pen dot matrix for mag marking, ridged floorplate edges for better grip, and capacity indicator windows. Drops free loaded or unloaded. All with the same boring reliability you expect from an OEM magazine. Compatible with all full-size, compact, and sub-compact double-stack Glock 9mm variants with some protrusion below the grip.



9 x 19

BLK

NEW PRODUCT

PMAG 27 GL9

MAG662 | **MSRP \$21.95** | 9X19MM

The PMAG 27 GL9 is a 27-round Glock 9mm handgun magazine featuring a new proprietary all-polymer construction for flawless reliability and durability over thousands of rounds. Meeting the overall length requirements for a 170MM competition magazine, the PMAG 27 GL9 offers additional capacity without the need for expensive extensions. High visibility controlled-tilt follower, stainless steel spring, easily removable floorplate for cleaning, paint pen dot matrix for mag marking, ridged floorplate edges for better grip, and capacity indicator windows. Drops free loaded or unloaded. All with the same boring reliability you expect from an OEM magazine. Compatible with all full-size, compact, and sub-compact double-stack Glock 9mm variants with some protrusion below the grip.



9 x 19

BLK



PMAG 15 GL9

MAG550 | **MSRP \$15.95** | 9X19MM

The PMAG 15 GL9 is a 15-round magazine featuring durable polymer construction, paint pen dot-matrix for labeling, tool-less floor plate removal for ease of maintenance, a visible capacity indicator hole on the body, and Magpul reliability. Compatible with all compact (G19 Sized) 9mm Glock handguns and subcompact 9mm Glock handguns with some protrusion below the grip.



9 x 19

BLK

PMAG 17 GL9

MAG546 | **MSRP \$15.95** | 9X19MM

The PMAG 17 GL9 is a 17-round magazine featuring durable polymer construction, paint pen dot-matrix for labeling, tool-less floor plate removal for ease of maintenance, and a visible capacity indicator hole on the body. The PMAG 17 GL9 is compatible with all full-size 9mm Glock handguns, as well as compact and sub-compact variants with some protrusion below the grip.



9 x 19

BLK



NEW PRODUCT

PMAG FLOOR PLATE - GL9

5-PACK

MAG688 | **MSRP \$9.95** | 9X19MM

Made utilizing Magpul's unique Sand material, the PMAG Floor Plate fits all PMAG GL9 series magazines. The Sand PMAG Floor Plate can be utilized as is, or dyed to nearly any color using readily available commercial dyes. Available in 5-packs to allow for customizable marking and identification.



9 x 19

SND



MAGPUL GL L-PLATE

MAG567 | **MSRP \$19.95** | 3 PACK

Made of durable polymer with a rubber overmold, the Magpul GL L-Plate fits all PMAG GL9 series magazines. Designed to aid in seating of the magazine with extended magazine wells, the GL L-Plate offers positive traction and impact protection without unnecessary bulk. Available in packs of 3, the GL L-Plate is tailor made for competition or defensive use.



3 x 18



BLK



MOE 1911 GRIP PANELS WITH TSP TEXTURE

MAG544 | **MSRP \$19.95**

Created as a variation on the original MOE 1911 grip panels, the 1911 Grip Panels with TSP texture offer the user a more aggressive texture allowing for better control of the weapon system. Constructed of reinforced polymer, the grips have a unique diamond-shaped cross-section to prevent twisting in the hand, an aggressive magazine release cut-out, aggressive TSP texture for positive control, and are compatible with ambidextrous safeties. The grips are designed to fit full size framed 1911s with standard grip screw bushings.



MOE

BLK

FDE

ODG

GRY



MOE 1911 GRIP PANELS

MAG524 | **MSRP \$19.95**

The instructors for Magpul's training division wanted a 1911 grip with advanced features, improved control characteristics, and Magpul value. These grips were designed with their input and testing. Constructed of heavy-duty reinforced polymer, MOE 1911 Grip Panels have a unique diamond-shaped cross section to prevent twisting in the hand, an aggressive magazine release cut-out, textured for positive control, and are compatible with ambidextrous safeties. The grips are designed to fit full size framed 1911s with standard grip screw bushings.



MOE

BLK

FDE

ODG

GRY

PNK





STOCKS

THE ODDS ARE GOOD THAT WE MAKE A STOCK FOR YOU. IF WE DON'T, YOUR ODDS ARE GETTING BETTER ALL THE TIME.

In addition to the most expansive line of AR15 and AK stocks available, we've branched out over the the last few years. Whether you shoot Remington 870, Mossberg 500, Remington 700 in long or short action, Ruger 10/22s, and a few more we haven't announced yet, we have refined the human interface for your platform. Every Magpul stock is designed with the same rigid adherence to quality and design. Within that philosophy, a wide variety of different requirements must be met, which has led to the development of a broad and ever expanding stock line. It doesn't matter if you are a professional user, hunter, competitor, or plinker, we've got a stock to help you reach the next level.



MAGPUL

STOCKS



MOE SL-S CARBINE STOCK

MAG653 | **MSRP \$79.95** | MIL SPEC RECEIVER EXTENSION

The storage-capable version of the flagship Magpul MOE SL carbine stock, the MOE SL-S (Storage) Stock is a direct replacement buttstock for AR15/M4 carbines. The sleek profile, dual-side release latches, and waterproof battery tubes make it the slimmest storage tube stock available. The SL-S provides the enhanced cheek weld and true, O-ring sealed, 10m waterproof storage area desired by many, but fits it into the narrowest package possible to allow a more upright head position and minimize bulk. A rolled toe and angled rubber butt-pad are optimized for use with body armor, and QD sling socket is included. A unique leaf-spring tension system provides a solid fit on mil-spec receiver extensions, with slightly less friction than the original SL. The MOE SL-S is the most intuitive, comfortable, and efficient storage stock available.



MOE

BLK | FDE | ODG | GRY

MOE SL CARBINE STOCK

MAG347 | **MSRP \$59.95** | MIL SPEC RECEIVER EXTENSION
MAG348 | **MSRP \$59.95** | COMMERCIAL SPEC RECEIVER EXTENSION

The Magpul MOE SL Stock is a direct replacement buttstock for AR15/M4 carbines. Designed for the modern battlefield, the sleek profile, dual-side release latches, rolled toe, and angled rubber butt-pad is optimized for use with body armor or modular gear and provides for efficient shoulder transitions.



MOE

BLK | FDE | ODG | GRY
MAG348-BLK ONLY

MOE SL-K CARBINE STOCK

MAG626 | **MSRP \$39.95** | MIL SPEC RECEIVER EXTENSION

Inspired by the XM-177 stock from the earliest models of compact AR-rifles, the Magpul MOE SL-K Stock is a direct replacement compact buttstock for AR15/M4 Carbines. Ideal for SBRs, PDW's, and submachine guns, the SL-K is optimized for platforms where size and weight are at a premium. Designed for the modern battlefield, the reduced footprint, shielded dual-side anti-rattle release latches, optional QD sling mounting*, rolled toe, and angled rubber butt-pad make it ideal for use on compact weapons and for achieving solid stock placement when wearing bulky armor. The SL-K is not a low-cost alternative to other stocks, it is designed for maximum performance with minimal bulk. [*Rear slot in the SL-K allows mounting the M-LOK QD Sling Mount, sold separately.]



MOE

BLK | FDE | ODG | GRY

MAGPUL

STOCKS



MOE FIXED CARBINE STOCK

MAG480 | **MSRP \$29.95** | MIL SPEC RECEIVER EXTENSION
 MAG481 | **MSRP \$29.95** | COMMERCIAL SPEC RECEIVER EXTENSION

The MOE Fixed Carbine Stock provides a fixed, non-collapsing stock option for carbine-length buffer tubes. The MOE Fixed Carbine Stock has a slim profile, multiple sling attachment options including integrated sling loops and optional dualside QD mounting points, and is compatible with the ASAP Plate and PRS Extended Rubber Butt-Pad. Installation is non-armorer and does not require the castle nut or lock plate to be removed.

MOE CARBINE STOCK

MAG400 | **MSRP \$39.95** | MIL SPEC RECEIVER EXTENSION
 MAG401 | **MSRP \$39.95** | COMMERCIAL SPEC RECEIVER EXTENSION

The MOE Carbine Stock is a cost-effective replacement for the standard M4 stock body, offering enhanced strength and ergonomics. The Magpul Original Equipment (MOE) stock offers Magpul engineering and material quality in an economical package. Utilizing a strong A-frame design, reinforced polymer construction, streamlined exterior, rubber butt-pad, and shielded operation lever.

CTR CARBINE STOCK

MAG310 | **MSRP \$59.95** | MIL SPEC RECEIVER EXTENSION
 MAG311 | **MSRP \$59.95** | COMMERCIAL SPEC RECEIVER EXTENSION
 NSN: 1005-01-614-7778 (BLK)

The CTR Carbine Stock is a fully-featured drop-in replacement for the standard M4 stock body, offering enhanced strength, stability, and ergonomics. Designed for stability, the Compact/Type Restricted (CTR) stock utilizes a strong A-frame design, reinforced polymer construction, shielded operation lever, and a friction locking system to mitigate excessive stock movement. The CTR comes standard with dual-side QD sling mount and rubber butt-pad.

STR CARBINE STOCK

MAG470 | **MSRP \$79.95** | MIL SPEC RECEIVER EXTENSION
 MAG471 | **MSRP \$79.95** | COMMERCIAL SPEC RECEIVER EXTENSION
 NSN: 1005-01-619-8860 (BLK)

The Magpul STR (Storage/Type Restricted) is a drop-in replacement buttstock for AR15/M4 carbines. A storage-capable version of the CTR, the STR has improved cheek weld and two water resistant battery tubes on a compact, reinforced polymer A-frame design. A shielded operation lever and supplemental friction locking system prevent accidental operation and minimize excessive stock movement for enhanced weapon stability and accuracy. The STR incorporates two integral sling loops, a reversible push-button QD sling mount, and a replaceable 0.30" rubber butt-pad which provides positive shoulder purchase to prevent slippage even with body armor or modular gear.

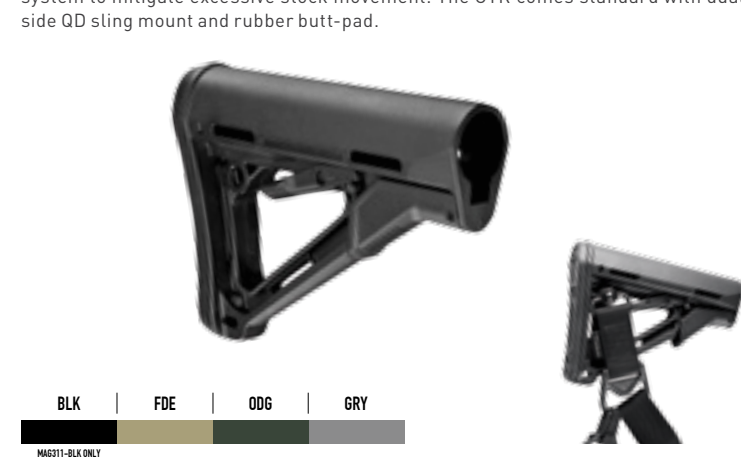



ACS CARBINE STOCK

MAG370 | **MSRP \$89.95** | MIL SPEC RECEIVER EXTENSION
 MAG371 | **MSRP \$89.95** | COMMERCIAL SPEC RECEIVER EXTENSION

The ACS Carbine Stock is a drop-in replacement for the standard M4 stock body, offering enhanced strength, stability, battery/equipment storage, and improved cheek weld. The Adaptive Carbine/Storage (ACS) stock features a comfortable sloping cheek weld, robust reinforced polymer construction, dual-side battery storage tubes, an integral storage compartment, and friction locking mechanism to eliminate excess stock movement. 0.30" thick rubber butt-pad included.



BLK | FDE | ODG | GRY
MAG371-BLK ONLY

ACS-L CARBINE STOCK

MAG378 | **MSRP \$79.95** | MIL SPEC RECEIVER EXTENSION
 MAG379 | **MSRP \$79.95** | COMMERCIAL SPEC RECEIVER EXTENSION

The Magpul ACS-L (Adaptable Carbine Stock - Light) is a drop-in replacement butt-stock for AR15/M4 carbines. A streamlined version of the ACS, the ACS-L utilizes the same center storage compartment and cheek weld but removes the battery tubes for a slimmer, lighter weight package.



BLK | FDE | ODG | GRY
MAG378-BLK ONLY



NEW PRODUCT

UBR GEN2 CARBINE STOCK

MAG482 | **MSRP \$199.95** | AR15/M16/ AR10/SR25/M110 RIFLES

The UBR GEN2 is an adjustable stock for the AR15/M4, designed to offer the same strength and stability as a fixed stock with a consistent and comfortable cheek weld in any position. An update of the revolutionary Utility/Battle Rifle (UBR) stock, the UBR GEN2 features a fixed cheek piece to provide a consistent cheek weld in any of its 8 positions, and is compatible with A5-length buffer systems. Designed to accommodate largebore AR calibers and withstand severe impacts, the UBR comes standard with front and rear QD sling attachment points, a recessed footman's loop, the ergonomic MOE SL angled-toe rubber butt-pad, and storage compartment. Buffer tube included.



BLK | FDE | ODG | GRY



NEW PRODUCT

PRs GEN3 RIFLE STOCK

MAG672 | **MSRP \$254.95** | AR15/M16/ AR10/SR25/M110 RIFLES

The PRS3 is a field precision stock for AR15/M16 and AR10/SR25 platforms, featuring tool-less length of pull and cheek piece height adjustment. Adjustable for length of pull and cheek piece height via aluminum detent knobs, the PRS3 (Precision Rifle/Sniper) stock is intended for semi automatic sniper or varmint type rifles. Optimized for installation on rifle-length, mil-spec carbine, and A5 length carbine receiver extensions and includes a cant/height-adjustable rubber butt-pad and rotation-limiting QD sling cups as well as M-LOK slots on the bottom for rear monopod mounting.



PRs2 RIFLE STOCK

MAG340 | **MSRP \$255.95** | HK G3/91
MAG341 | **MSRP \$255.95** | FN FAL

The PRS2 is a field precision stock for the FN FAL or HK G3/91, featuring toolless length of pull and cheek piece height adjustment. Adjustable for length of pull and cheek piece height via aluminum detent knobs, the PRS2 (Precision Rifle/Sniper) stock is intended for semi automatic sniper or varmint type rifles. The FAL variant installs on metric pattern rifles. The G3/91 utilizes the factory standard buffer unit.



MOE RIFLE STOCK

MAG404 | **MSRP \$69.95** | AR15/M16/ AR10/SR25/M110 RIFLES

The MOE Rifle Stock is a simple, lightweight, cost-effective stock for the AR15/M16 and AR10/SR25 platforms, with an enhanced cheek weld, rubberized buttpad, and internal storage compartment. The MOE Rifle Stock is a drop-in replacement for A1 and A2 rifle stocks utilizing the standard rifle-length receiver extension (buffer tube) without the A2 spacer. Designed as a basic rifle upgrade, the stock features an improved cheek weld profile, integral 1.25" sling loop, optional dual-side front and rear QD mounting points, replaceable anti-slip rubberized butt-pad, and large internal storage compartment accessible through the rear storage door.



MOE



STOCK COMPARISON



	MOE SL CARBINE	MOE SL-S CARBINE	MOE SL-K CARBINE	MOE CARBINE	CTR CARBINE	STR CARBINE	ACS-L CARBINE		ACS CARBINE	UBR GEN2	MOE FIXED CARBINE	MOE RIFLE	PRS2	PRS GEN3
SKU	MAG347 MAG348	MAG653	MAG626	MAG400 MAG401	MAG310 MAG311	MAG470 MAG471	MAG378 MAG379		MAG370 MAG371	MAG482	MAG480 MAG481	MAG404	MAG341 MAG340	MAG672
MSRP	\$59.95 \$59.95	\$79.95	\$39.95	\$39.95 \$39.95	\$59.95 \$59.95	\$79.95 \$79.95	\$79.95 \$79.95		\$89.95 \$89.95	\$199.95	\$29.95 \$29.95	\$69.95	\$255.00 \$255.00	\$254.95
TUBE TYPE	MIL SPEC COMMERCIAL	MIL SPEC	MIL SPEC	MIL SPEC COMMERCIAL	MIL SPEC COMMERCIAL	MIL SPEC COMMERCIAL	MIL SPEC COMMERCIAL		MIL SPEC COMMERCIAL	PROPRIETARY LENGTH INCLUDED	MIL SPEC COMMERCIAL	RIFLE BUFFER TUBE	FN FAL HK G3/91	MIL SPEC OR RIFLE BUFFER TUBE
WEIGHT	9.6 OZ. 9.6 OZ.	12 OZ.	8 OZ.	8.1 OZ. 8.5 OZ.	8.8 OZ. 9.3 OZ.	12.3 OZ. 12.3 OZ.	12.5 OZ. 12.5 OZ.		14.0 OZ. 14.0 OZ.	21.3 OZ.	12.25 OZ.	14.0 OZ.	30.2 OZ. 30.9 OZ.	27.8 OZ.
LENGTH OF PULL	10.8" - 14.1" 10.8" - 14.9"	10.9" - 14.2"	10.3" - 13.6"	10.5" - 13.8" 10.8" - 14.6"	10.5" - 13.8" 10.8" - 14.6"	10.9" - 14.2" 10.9" - 14.7"	11.6" - 15.4" 10.9" - 14.7"		11.75" - 15.00" 11.75" - 15.55"	11.75" - 15.25"	12.375" 12.375"	13.50"	14.30" - 15.5" 15.00" - 16.20"	14.30" - 15.7"
COLOR	BLK - FDE - ODG - GRY	BLK - FDE - ODG - GRY	BLK - FDE - ODG - GRY	BLK - FDE - ODG - GRY - PNK MAG401 BLK	BLK - FDE - ODG - GRY MAG311 BLK	BLK - FDE - ODG - GRY MAG471 BLK	BLK - FDE - ODG - GRY MAG379 BLK		BLK - FDE - ODG - GRY MAG371 BLK	BLK - FDE - ODG - GRY	BLK - FDE - ODG - GRY MAG481 BLK	BLK - FDE - ODG - GRY	BLK	BLK - FDE - ODG - GRY
COMPATIBILITY	AR15 - M4 - AR10 SR25 - M110	AR15 - M4 - AR10 SR25 - M110	AR15 - M4 - AR10 SR25 - M110	AR15 - M4 - AR10 SR25 - M110	AR15 - M4 - AR10 SR25 - M110	AR15 - M4 - AR10 SR25 - M110	AR15 - M4 - AR10 SR25 - M110		AR15 - M4 - AR10 SR25 - M110	AR15 - M4 - AR10 SR25 - M110	AR15 - M4 - AR10 SR25 - M110	AR15 - M16 - AR10 SR25 - M110	FAL (METRIC) HKG3/91	AR15 - M4 - AR10 SR25 - M110
COLLAPSIBLE	■	■	■	■	■	■	■		■	■				■
FRICTION LOCK	TUBE TENSION SYSTEM	TUBE TENSION SYSTEM	TUBE TENSION SYSTEM		■	■	■		■					
CHANGEABLE BUTT-PAD	■	■		■	■	■	■		■	■	■	■	■	■
IMPROVED CHEEKWELD	■	■	■			■	■		■	■		■	■	■
STORAGE		■					■		■	■		■		
BATTERY STORAGE		■					■		■					
ADJUSTABLE CHEEKPIECE													■	■
SLING LOOP	■	■	■	■	■	■	■		■	■	■	■	■	■
QD CUP MOUNT POINTS	■	■			■	■	■		■	■	AVAILABLE	AVAILABLE	■	■
BOTTOM ACCESSORY RAIL												AVAILABLE		AVAILABLE
ASAP COMPATIBLE	■	■	■	■	■	■	■		■		■			

NEW
PRODUCT

HEAT-TREATED CASTLE NUT

MAG817 | **MSRP \$4.95** | AR15/M4

The Heat-Treated Castle Nut screws onto the AR15/M4 lower receiver extension (buffer tube) and keeps the receiver extension and lower receiver end plate secured in place. The large notches allow for positive engagement with a castle nut wrench for proper installation and torque. The smaller notches provide a location for the end user to stake the castle nut to prevent accidental loosening. Finished in a Mil-spec manganese phosphate.

NEW
PRODUCT

RECEIVER END PLATE

MAG818 | **MSRP \$4.95**

The Receiver End Plate is made of steel with a Mil-spec manganese phosphate finish. The engagement tab allows for proper alignment of the receiver extension with the lower receiver. Its steel construction is optimal for proper staking with the castle nut.



ENHANCED RECEIVER EXTENSION

NEW
PRODUCTMAG677 | **MSRP \$49.95** | AR15/M4 - 7 POSITIONMAG678 | **MSRP \$59.95** | SR25/M110 - 10 POSITION

Constructed of impact extruded 7075-T6 aluminum with Type III, Class 2 hard coat anodizing for an extremely hard, abrasion resistant surface. The interior of the receiver extension features Everlube® coating for enhanced corrosion resistance and reduced friction and wear. The additional position holes allow for more length-of-pull fitment options.



BLK

AR15/M4 BUFFER TUBES

NEW
PRODUCTMAG812 | **MSRP \$11.95** | AR15/M4 CARBINE BUFFER - 3.0 OZMAG813 | **MSRP \$22.95** | AR15/M4 H CARBINE BUFFER - 3.8 OZMAG814 | **MSRP \$32.95** | AR15/M4 H2 CARBINE BUFFER - 4.7 OZMAG816 | **MSRP \$39.95** | AR15/M4 H3 CARBINE BUFFER - 5.4 OZ

These Mil-spec construction AR15/M4 Carbine Buffer are for use in AR15/M4 carbine-type receiver extensions.



STAINLESS STEEL AR15/M4 CARBINE BUFFER SPRING

NEW
PRODUCTMAG810 | **MSRP \$4.95** | AR15/M4 CARBINE

The Carbine Buffer Spring is a high-quality replacement spring for the AR15/M4 family of weapons with carbine receiver extensions and buffers. This stainless steel spring will perform reliably in any properly configured and maintained 5.56x45 carbine.



STAINLESS STEEL AR15/M16 RIFLE BUFFER SPRING

NEW
PRODUCTMAG811 | **MSRP \$4.95** | AR15/M16 RIFLE

The Rifle Buffer Spring is a high-quality replacement spring for the AR15/M16 family of weapons with rifle receiver extensions and buffers. This stainless steel spring will perform reliably in any properly configured and maintained 5.56x45 rifle.





MOE SL ENHANCED BUTT-PAD

MAG349 | **MSRP \$19.95** | 0.70" • MOE SL, MOE AK, UBR GEN2 & ZHUKOV-S

The MOE SL Enhanced Butt-Pad is a direct replacement butt-pad for the MOE SL, MOE AK, and Zhukov-S stocks. The ribbed surface offers an anti-slip purchase during use. The thicker, vented design provides enhanced user comfort as well as approximately .5" additional length of pull and less than 1oz to the overall weight of the stock.



MOE
BLK

REPLACEMENT BUTT-PADS

MAG315 | **MSRP \$19.95** | 0.30" • MOE, CTR, STR, ACS, ACS-L & UBR
MAG316 | **MSRP \$19.95** | 0.55" • MOE, CTR, STR, ACS, ACS-L & UBR

These Rubber Butt-Pads come standard with many of our carbine stocks and utilize a firm rubber that is designed for enhanced shoulder purchase and improve impact/drop mitigation. Commercial Butt-Pad (0.55") may be used with all Milspec MOE, CTR, STR, ACS-L, ACS and UBR stocks for 0.25" increased length-of-pull.



BLK

PRS EXTENDED BUTT-PAD

MAG350 | **MSRP \$14.95** | PRS & MOE FIXED STOCKS
NSN#: 1005-01-591-5976

The PRS Extended Rubber Butt-Pad replaces the standard 0.30" thick rubber butt-pad, adding approximately 0.50" to the original length of pull. Compatible with PRS AR15/M16 and AR10/SR25, MOE Fixed Carbine Stock, MOE Rifle Stock.



BLK

ENHANCED BUTT-PAD

MAG317 | **MSRP \$19.95** | 0.70" • MOE, CTR, STR, ACS, ACS-L & UBR
NSN#: 1005-01-591-5966

The 0.70" thick Enhanced Rubber Butt-Pad can be installed on all UBR, ACS, ACS-L, STR and Milspec MOE/CTR stocks. The Enhanced Rubber Butt-Pad can also be installed on Commercial MOE/CTR stocks, but may prohibit use of fully collapsed position.



BLK

PRS2 EXTENDED BUTT-PAD

MAG342 | **MSRP \$14.95** | PRS2 & ACR STOCKS
NSN#: 1005-01-591-5982

The PRS2 Extended Rubber Butt-Pad replaces the standard rubber butt-pad, adding approximately 0.50" to the original length of pull. Compatible with PRS2 for HK G3/91 and FAL.



BLK

CHEEK RISERS

MAG325 | **MSRP \$19.95** | 0.25" • MOE & CTR STOCKS
MAG326 | **MSRP \$19.95** | 0.50" • MOE & CTR STOCKS
MAG327 | **MSRP \$19.95** | 0.75" • MOE & CTR STOCKS
NSN#: 1005-01-591-6018 (MAG325-BLK)
1005-01-591-6035 (MAG326-BLK)
1005-01-591-6041 (MAG327-BLK)

Clip on cheek risers for the MOE and CTR stocks. Raises cheek weld .25, .50, or .75 inch in height. These risers are for use on NON AR15/M4 applications as the riser will interfere with charging handle function. Originally designed for M14 carbine stock conversions.

NOTE: MAY INTERFERE WITH CHARGING HANDLE IF INSTALLED ON AR15/M4 RIFLES

BLK | FDE | ODG | GRY



QD SLING MOUNT KITS

MAG333 | **MSRP \$19.95** | TYPE 1 • SGA SHOTGUN, MOE RIFLE & MOE FIXED CARBINE
MAG332 | **MSRP \$19.95** | TYPE 2 • DUAL SIDE UBR, STR, SGA HUNTER, MOE RIFLE & MOE FIXED CARBINE

Sling mount kits for attaching push-button QD sling swivels to specific Magpul stocks. Heavy-duty black phosphate finished steel construction easily installs with stock's original hardware. Swivels not included.



BLK



GRIPS

THE GRIP IS ONE OF THE MOST IMPORTANT INTERFACES BETWEEN MAN AND MACHINE, MAKING THE “RIGHT” GRIP PREFERENCE A VERY PERSONAL THING.

Our MOE Grip was designed based on user input from individuals with very different hand sizes and shapes, with the angle, size, trigger reach, and texture that suited a vast majority of users. For those who like a softer, more “tacky” grip, the MOE+ offers the size and shape of the MOE with a rubber overmold onto our sturdy polymer core. The MIAD GEN 1.1 offers customizable options to accommodate larger and smaller hands, different preferences in front strap style, and comes in variants to fit 5.56 and 7.62 sized lowers.

For those looking for a more vertical grip angle, desired by many using “short stock”, squared-off shooting styles or smaller, PDW style weapons, the MOE-K provides a truly compact, less angled solution with an aggressive TSP texture. The MOE SL grip (MOE Slim Line) is an upgrade for AR15/M4 pistol grips with an aggressive TSP texture for positive weapon control along with excellent ergonomics. The SL Grip provides a slightly smaller size than full grips and slim line feel. The MOE-K2 provides a unique shape that gives you a more vertical grip angle along with optimized trigger reach geometry. The MOE-K2+ grip combines reinforced polymer body construction with comfortable wrap-around rubber overmolding for maximum weapon control in adverse environments. Most of our grips work with our interchangeable cores, and have several options to allow secure storage of various items. In 2017 expect additions to the grip line for various platforms.





MOE SL GRIP

MAG539 | **MSRP \$19.95**

Similar to the MOE-K2, the MOE SL Grip (Magpul Original Equipment Slim Line) is a drop-in upgrade for AR15/M4 pistol grips with a more vertical grip angle optimized for short LOP weapons that bring the primary hand in closer to the shooter's body. With an aggressive new texture for positive weapon control along with excellent ergonomics, the SL Grip provides a slightly smaller size and slimline feel. The MOE SL Grip is not compatible with Grip Cores.

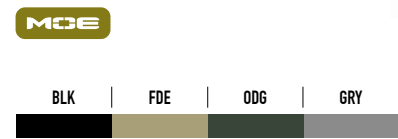

MIAD GEN 1.1

MAG520 | **MSRP \$35.95** | TYPE 1 (MOST 5.56 & 7.62 RECEIVERS)
MAG521 | **MSRP \$35.95** | TYPE 2 (SOME 7.62 RECEIVERS)

The MIAD (Mission ADaptible) Grip is a drop-in replacement for standard grips, and is now available in both 5.56 and 7.62 configurations. It is designed to improve ergonomics with an aggressive texture for positive weapon control and interchangeable front and rear straps for personalized hand fit, and is compatible with all Magpul Grip Cores. The new MIAD Grip also comes with the newest grip core; a lubrication bottle* storage core.

*Note: empty bottle included.

Fitment chart available at www.magpul.com.



GRIP CORES

MAG055 | **MSRP \$14.95** | CR123A
MAG056 | **MSRP \$14.95** | AA/AAA
MAG057 | **MSRP \$14.95** | BOLT AND FIRING PIN
MAG059 | **MSRP \$14.95** | LUBE BOTTLE

MAG055 is designed to hold two (2) CR123A lithium type batteries in a self contained water resistant unit. Rubber cap is captured to the unit and can be opened with a push of the thumb. MAG056 is designed to hold two (2) AA type batteries in a self contained water resistant unit. Included internal spacer provides rattle free storage of either (2) AAA or (2) N size batteries (commonly used for EOTech sights). MAG057 is designed to hold one (1) AR15/M4 complete bolt and firing pin. MAG059 is designed to hold one (1) standard lubrication bottle*.

*Note: empty bottle included.



MOE-K2+ GRIP

MAG532 | **MSRP \$24.95**

The MOE-K2+ combines reinforced polymer body construction with comfortable, wrap around rubber over molding for maximum weapon control in adverse conditions. The steeper vertical grip angle is optimized for use on PDW (Personal Defense Weapon) configurations and improves comfort and control on short LOP rifles that bring the primary hand in closer to the shooter's body. The MOE-K2+ accepts optional storage cores for gear stowage and includes a basic cap.

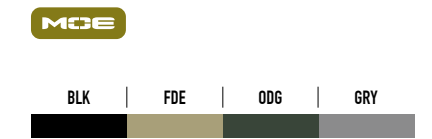



MOE-K2 GRIP

MAG522 | MSRP \$20.95

The MOE-K2 is a drop in upgrade for AR15/M4 pistol grips with a more vertical grip angle optimized for short LOP weapons, such as PDW (Personal Defense Weapons) configurations. It has an aggressive texture for positive weapon control and is compatible with Magpul Grip Cores for storage customization.



MOE-K GRIP

MAG438 | MSRP \$19.95

The MOE-K Grip provides an extremely low profile and compact design with a steeper grip angle compared to more traditional styles. The more vertical grip angle is optimized for use on PDW (Personal Defense Weapon) configurations and improves comfort and control on short LOP rifles that bring the primary hand in closer to the shooter's body. The thin profile and lack of backstrap 'beavertail' also makes it an excellent choice for shooters who prefer a smaller grip circumference for the AR15/M4 pistol grip. The MOE-K Grip is not compatible with Grip Cores.

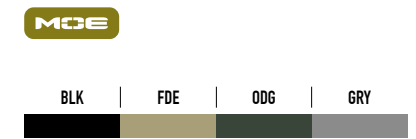

MOE+ GRIP

MAG416 | MSRP \$23.95

The MOE+ Grip combines reinforced polymer body construction with comfortable, wrap-around rubber overmolding for maximum weapon control in adverse environments. Drop-in design features a hard-polymer bottom edge to reduce the possibility of equipment snags or overmold damage. The MOE+ Grip accepts optional storage cores for gear stowage.

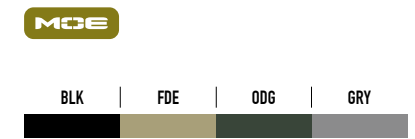

MOE GRIP

MAG415 | MSRP \$19.95

The MOE Grip provides Magpul quality, feel, and durability in an economical, drop-in upgrade for the standard AR15/M4 pistol grip. The ergonomic, hand-filling design combines aggressive texturing with storage core capability. One-piece reinforced polymer construction provides the durability needed to withstand operational environments. The MOE Grip accepts optional storage cores for gear stowage.

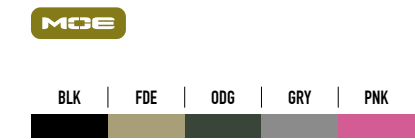



AFG ANGLED FORE-GRIP

MAG411 | **MSRP \$34.95** | 1913 PICATINNY RAIL

Unlike conventional vertical fore-grips, the Magpul AFG (Angled Fore-Grip) takes into account natural body mechanics and provides a comfortable and stable user interface that reduces fatigue and allows for more precise weapon control. By positioning the shooter's hand high on the centerline of the bore, the AFG helps mitigate recoil and control the weapon, facilitating faster, more accurate follow-up shots.

AFG-2 ANGLED FORE-GRIP

MAG414 | **MSRP \$34.95** | 1913 PICATINNY RAIL
NSN: 1005-01-613-6261 (BLK)

Taking into account body mechanics and ergonomic considerations, the AFG-2 provides a forward grip/index point that reduces shooter fatigue and enhances weapon control. Slim line design and small size allows for compatibility with a wide variety of rail systems, rail covers, and accessory mounts. The AFG-2 features a three-piece design with an interchangeable finger shelf that allows for a flat "A1-style" surface or an "A2-style" finger nub, depending on shooter preference. It mounts on standard 1913 Picatinny rails.



RVG RAIL VERTICAL GRIP

MAG412 | **MSRP \$24.95** | 1913 PICATINNY RAIL
NSN: 1005-01-591-6133 (BLK)

Designed for use with Mil-Spec 1913 Picatinny railed hand guards, the RVG is a basic, lightweight, cost-effective vertical fore-grip. The RVG shape is ergonomically designed for use as a traditional vertical grip, but is also optimized for use with the "thumb forward" method of shooting. All mounting hardware included.



XTM HAND STOP KIT

MAG511 | **MSRP \$19.95** | 1913 PICATINNY RAIL
NSN: 1005-01-616-4881 (BLK)

The 4-piece XTM Hand Stop Kit serves as a lightweight, low-profile rail mounted index point for improved weapon control, or as a forward stop to prevent the shooter's hand from reaching the hot front sight assembly or muzzle. The kit includes one Hand Stop, one Index Panel, one full XTM Enhanced Panel, and one XTM Enhanced Half Panel.



MAG



FOR M-LOK ACCESSORIES
SEE NEXT SECTION

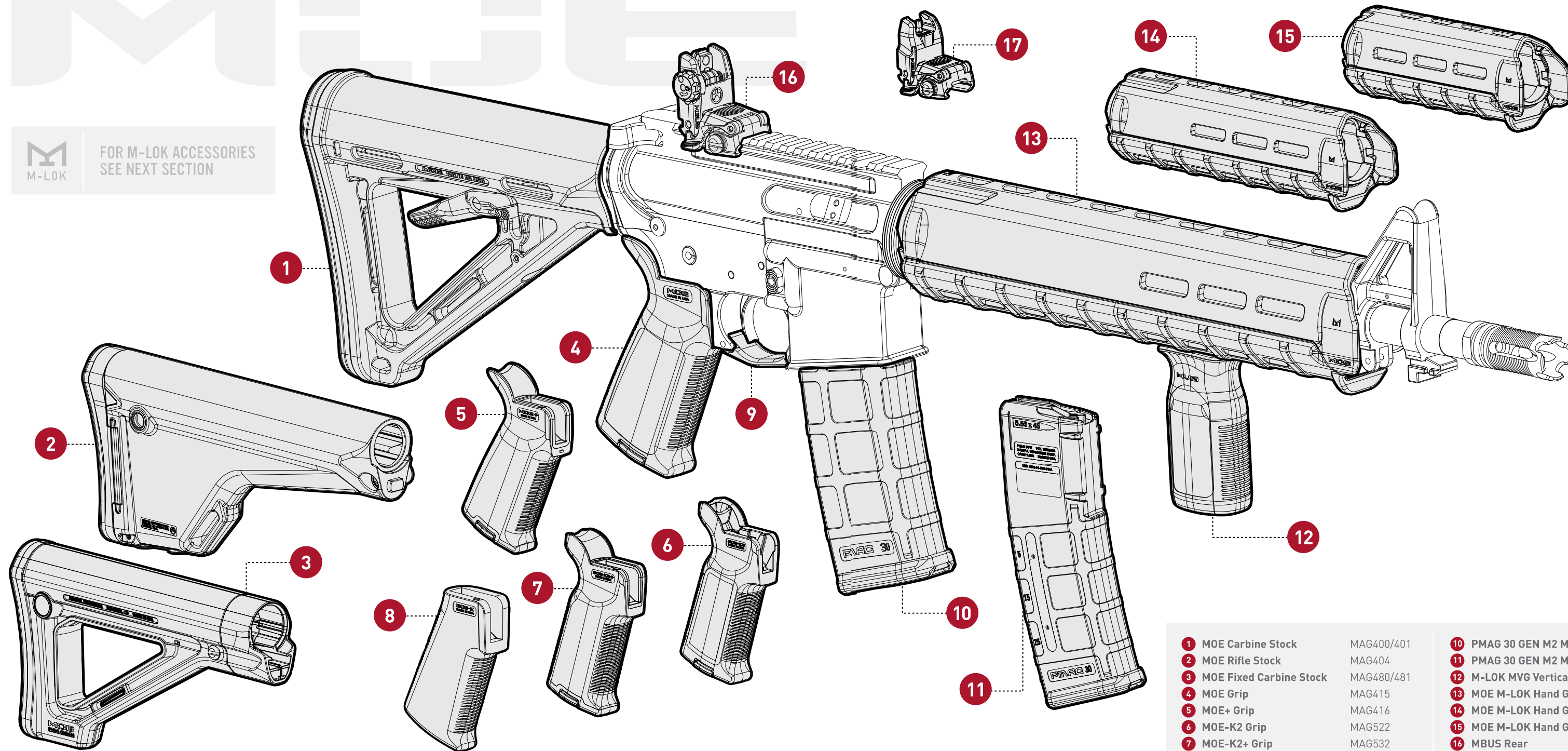

- | | | | |
|---------------------------|------------|----------------------------------|--------|
| 1 MOE Carbine Stock | MAG400/401 | 10 PMAG 30 GEN M2 MOE | MAG571 |
| 2 MOE Rifle Stock | MAG404 | 11 PMAG 30 GEN M2 MOE W | MAG570 |
| 3 MOE Fixed Carbine Stock | MAG480/481 | 12 M-LOK MVG Vertical Grip | MAG597 |
| 4 MOE Grip | MAG415 | 13 MOE M-LOK Hand Guard, Rifle | MAG427 |
| 5 MOE+ Grip | MAG416 | 14 MOE M-LOK Hand Guard, Mid | MAG426 |
| 6 MOE-K2 Grip | MAG522 | 15 MOE M-LOK Hand Guard, Carbine | MAG424 |
| 7 MOE-K2+ Grip | MAG532 | 16 MBUS Rear | MAG248 |
| 8 MOE-K Grip | MAG438 | 17 MBUS Front | MAG247 |
| 8 MOE Trigger Guard | MAG417 | | |



M-LOK

In 2007, Magpul introduced the first negative space attachment system for firearms with what became our MOE slot system. No longer was it necessary to use a Picatinny rail as an intermediate, and accessories could be direct-mounted to hand guards and other surfaces. Fast forward a few years. Other direct attachment systems came to market where access to the backside of the mounting surface was no longer needed...an improvement in usability. Not satisfied with just following market trends, we invested a significant amount of effort in testing existing systems in both polymer and aluminum to determine if we would incorporate the leading system into our accessories line. Falling in line and adopting an existing system certainly would have been an easier path to follow.

After shaker table testing, thousands upon thousands of rounds of live fire testing, drop testing, pullout testing, and manufacturing time and material studies, we developed and moved forward with the M-LOK slot system as a better solution in every metric we studied.

M-LOK is stronger, easier and faster to machine, has no sharp corners, has full four-way recoil lug support, is adjustable in small increments for position, is repeatable, and is generally considered visually appealing. It's not just us who think so...M-LOK has been adopted by nearly 400 manufacturers under a free licensing agreement that helps to guard compatibility and protect the consumer. Now fully incorporated into all Magpul Forends and Hand Guards, and supported with nearly two dozen Magpul accessories, plus many more from licensed manufacturers.

For more information, visit www.magpul.com/mlok



M SUPER MOD
M-LOK 13" LG PNEO



NEW PRODUCT

M-LOK TAPE SWITCH MOUNTING PLATE, INSIGHT® PEQ

MAG631 | **MSRP \$14.95** | INSIGHT PEQ

The M-Lok Tape Switch Mounting Plate is a mount designed to attach Insight PEQ pressure pads on M-Lok compatible systems. It is molded of the same high quality polymer as other Magpul products providing light weight with rugged construction, and the M-Lok recoil lugs and T-Nuts make for an extremely secure mounting system. A low profile design allows the user more mounting options without interfering with other equipment and it's rounded and beveled edges provides a snag free surface.



BLK

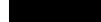

NEW PRODUCT

M-LOK GI SLING SWIVEL

MAG809 | **MSRP \$19.95**

The M-Lok GI Sling Swivel is a traditional sling swivel loop for M-Lok compatible systems. Its base is machined from Mil-Spec anodized aluminum and utilizes a coated steel loop, which accepts up to 1-1/4" sling webbing. With its compact and low profile design it provides a minimal footprint, which allows for more hand guard real estate. Like any other Magpul M-Lok accessory, the M-Lok GI Sling Swivel features recoil/impact mitigation lugs and cammed T-Nuts for proper M-Lok engagement.



BLK

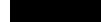



M-LOK TRIPOD ADAPTER

MAG624 | **MSRP \$49.95**

The M-LOK Tripod Adapter for metal M-LOK compatible hand guards or forends mounts directly onto any tripod head equipped with the common Manfrotto RC2/Q2 interface. This adapter allows the user to mount their rifle directly to a tripod head without the use of any additional saddles giving them a secure shooting platform. The M-LOK Tripod Adapter is machined from aluminum and finished in Mil-Spec anodizing which offers excellent corrosion resistance. The beveled ends and corners produce a minimal footprint allowing the user to keep the M-LOK Tripod Adapter attached to the weapon system at all times with minimal snagging hazards.



BLK

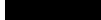

M-LOK AFG ANGLED FORE-GRIP

MAG598 | **MSRP \$26.95**

The M-LOK AFG is an M-LOK compatible update of the original Magpul AFG and AFG-2, the original products that changed the way shooters think about forend grips. A new radiused curve grip area allows greater freedom in placement of the M-LOK AFG on the hand guard while still maintaining correct wrist angles and ergonomics. A streamlined, minimalist design molded of our reinforced polymer material creates a one-piece, high strength grip that weighs a mere 1.2 ounces including hardware. The M-LOK AFG is 3/4" shorter than the AFG-2 while maintaining a similar gripping surface area for a smaller mounting footprint on hand guards with just as much room for the shooter's hand. The forward finger index, similar to the original AFG, provides additional options in gripping and hand placement, while a contoured rear surface allows placing the M-LOK AFG directly in front of an M-LOK MVG for a combination that provides even more versatility.



BLK | FDE | ODG | GRY



M-LOK MVG VERTICAL FORE-GRIP

MAG597 | **MSRP \$22.95**

The M-LOK MVG is made from the same high quality polymer as other Magpul products, and uses the new Magpul TSP texture for positive control in all environments. With rounded contours and a shorter length, the M-LOK MVG has been optimized for use with the "thumb break method" of shooting and can also be used as a traditional vertical foregrip.



BLK | FDE | ODG | GRY





M-LOK CANTILEVER RAIL ALUMINUM

MAG588 | **MSRP \$34.95**

Designed for use with all M-LOK mounting surfaces, the M-LOK Aluminum Cantilever Rail/Light Mount allows the attachment of various 1913 Picatinny spec rail-mounted accessories such as lights and optics, and directly interfaces with the popular Surefire M300/M600 series Scout Lights or Magpul Light Mount V-Block and Rings. The Cantilever Rail/Light Mount has Picatinny slots that extend forward .75"-1.5" past its mounting slot to improve ergonomics and optimize accessory positioning, while keeping lights and accessories low to reduce the weapon's profile. Machined from milspec-anodized aluminum, all hardware necessary for attachment directly to M-LOK slots is included.



3 Slots, max overall length of 3.15"



BLK

M-LOK CANTILEVER RAIL POLYMER

MAG587 | **MSRP \$17.95**

Designed for use with all M-LOK mounting surfaces, the M-LOK Cantilever Rail/Light Mount, Polymer allows the attachment of various 1913 Picatinny spec rail-mounted accessories, and directly interfaces with the popular Surefire M300/M600 series Scout Lights or Magpul Light Mount V-Block and Rings. The Cantilever Rail/Light Mount has Picatinny slots that extend forward .75"-1.5" past its mounting slot to improve ergonomics and optimize accessory positioning, while keeping lights and accessories low to reduce the weapon's profile. Injection molded from a proprietary reinforced compound for enhanced strength and durability while remaining lightweight.



3 Slots, max overall length of 3.15"



BLK

M-LOK OFFSET LIGHT/OPTIC MOUNT ALUMINUM

MAG604 | **MSRP \$34.95**

The M-LOK Offset Light/Optic Mount, Aluminum provides the user with an ambidextrous platform to mount weapons lights or optics at both the 11 and 1 o'clock positions on M-LOK compatible hand guards. This mounting solution is constructed of Mil-Spec anodized aluminum and has beveled ends and corners to prevent snagging. The Offset Light/Optic Mount allows for the direct attachment of the Surefire M300/600 Series Scout Light or other 1913 Picatinny mounts. The optional Magpul Light Mount V-Block and Rings can also be used to attach hand held lights with a diameter from .75" to 1.03".



BLK

M-LOK OFFSET LIGHT MOUNT POLYMER

MAG605 | **MSRP \$17.95**

The M-LOK Offset Light Mount, Polymer provides the user with an ambidextrous platform to mount weapons lights at both the 11 and 1 o'clock positions on M-LOK compatible hand guards. This mounting solution is constructed of polymer and has beveled ends and corners to prevent snagging. The Offset Light Mount allows for the direct attachment of the Surefire M300/600 Series Scout Light or other 1913 Picatinny mounts. The optional Magpul Light Mount V-Block and Rings can also be used to attach hand held lights with a diameter from .75" to 1.03".



BLK



M-LOK BIPOD ADAPTER

MAG609 | **MSRP \$22.95**

The Magpul M-LOK Bipod Mount allows for the mounting of bipods using the Harris-style attachment pattern. The M-LOK Bipod Mount offers a low-profile, robust, and elegant mounting solution for the most popular bipods on the market. Utilizing the direct connect properties of the M-LOK system, the bipod sits closer to the mounting surface than traditional M1913 bipod mounts, while providing superior support to the bipod for strength and stability. The Bipod Mount is also compatible with other accessories that attach to traditional sling studs.



M-LOK TAPE SWITCH MOUNTING PLATE

MAG617 | **MSRP \$14.95** | FOR SUREFIRE ST

The M-LOK Tape Switch Mounting Plate is designed to mount a Surefire ST pressure pad on M-LOK compatible systems. It is molded of the same high quality polymer as other Magpul products which provides a light weight product with extremely rugged construction. Its low profile design allows the user more mounting options without interfering with other equipment.



M-LOK QD SLING MOUNT

MAG606 | **MSRP \$19.95**

The M-LOK QD Sling Mount provides a forward attachment point for the Magpul MS4 Sling and other push-button QD slings. Machined from Mil-Spec anodized aluminum, the M-LOK QD Sling Mount is the perfect push-button QD mounting solution for M-LOK compatible hand guards and forends.



M-LOK PARACLIP SLING MOUNT

MAG607 | **MSRP \$19.95**

The M-LOK Paraclip Sling Mount is a steel clip-in sling mount for M-LOK compatible systems. It is constructed of high-grade, precision cast steel and has an extremely durable Melonite finish. With a low-profile and snag-free design it fits a wide range of clips, including the Magpul Paraclip.





M-LOK HAND STOP KIT

MAG608 | **MSRP \$24.95**

The M-LOK Hand Stop Kit serves as a light weight, low-profile M-LOK slot index point for improved weapon control, or as a forward stop to prevent the shooter's hand from reaching the hot front sight assembly or muzzle. The kit includes one M-LOK Hand Stop, one M-LOK Index Panel, and one M-LOK Rail Cover Type 2 for the individual user to configure their kit as they desire. Also included in this kit is an M-LOK Hand Stop MOE Adapter for use with Magpul Hand Guards or Forends as well as other wider profile rails.

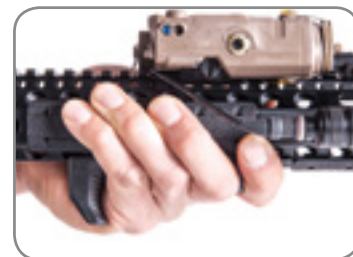

M-LOK RAIL COVER TYPE 1

MAG602 | **MSRP \$15.95**

M-LOK Type 1 Rail Covers are low-profile and light weight covers that install directly onto M-LOK compatible systems. Made of an extremely heat resistant material, these covers offer an enhanced gripping surface. At 9.5" in length they cover six full M-LOK slots but can be cut to be customized for length or combination of colors. Includes two panels.



M-LOK RAIL COVER TYPE 2

MAG603 | **MSRP \$12.95**

M-LOK Type 2 Rail Covers are low-profile, two-piece covers that install directly onto M-LOK compatible systems. These M-LOK Covers are non-orientation specific which allow the user to mount them in any direction desired without affecting function. The contact surfaces on these covers are textured using the Magpul TSP texture for additional grip, adding slightly more than 1/8" from the mounting surface, these covers also feature a beveled contour to minimize potential snagging. The locking tab is pre-scored down the center to allow the user to snap off sections and mix and match colors for a more custom look. Includes six panels.





M-LOK RAIL SECTION ALUMINUM

MAG580 | **MSRP \$17.95** | 3 SLOT | M-LOK HAND GUARDS & FORENDS
 MAG581 | **MSRP \$19.95** | 5 SLOT | M-LOK HAND GUARDS & FORENDS
 MAG582 | **MSRP \$21.95** | 7 SLOT | M-LOK HAND GUARDS & FORENDS
 MAG583 | **MSRP \$23.95** | 9 SLOT | M-LOK HAND GUARDS & FORENDS

Designed for use with all M-LOK compatible Hand Guards and Forends, M-LOK Aluminum Rail Sections allow the attachment of various 1913 Picatinny spec rail-mounted accessories such as lights, vertical grips, etc. Machined from Mil-Spec anodized aluminum, M-LOK Rail Sections also feature beveled ends to reduce snagging and eliminate sharp corners and edges.



BLK



M-LOK RAIL SECTION POLYMER

MAG589 | **MSRP \$9.95** | 3 SLOT | M-LOK HAND GUARDS & FORENDS
 MAG590 | **MSRP \$9.95** | 5 SLOT | M-LOK HAND GUARDS & FORENDS
 MAG591 | **MSRP \$13.95** | 7 SLOT | M-LOK HAND GUARDS & FORENDS
 MAG592 | **MSRP \$14.95** | 9 SLOT | M-LOK HAND GUARDS & FORENDS
 MAG593 | **MSRP \$15.95** | 11 SLOT | M-LOK HAND GUARDS & FORENDS

Designed for use with all M-LOK compatible Hand Guards and Forends, M-LOK Polymer Rail Sections provide a cost effective method of attaching various 1913 Picatinny spec rail-mounted accessories such as lights, vertical grips, etc. Injection molded from a proprietary reinforced composite for enhanced strength and durability while remaining lightweight. Rail Sections also feature beveled ends to reduce snagging and eliminate sharp corners and edges.



BLK

LIGHT MOUNT V-BLOCK & RINGS

MAG614 | **MSRP \$17.95**

The versatile Light Mount V-Block and Rings is a nearly-universal mounting solution for attaching a handheld light to compatible Magpul Light mounts. Constructed of reinforced polymer and milspec-anodized aluminum, the Light Mount V-Block and Rings allow the user to install lights with a body diameter from .75" to 1.04" onto the Magpul Rail Light Mount, MOE Scout Mount, M-LOK Cantilever Rail/Light Mount, and M-LOK Offset Light Mount. In conjunction with compatible Magpul Scout Light-compatible mounts, the Light Mount V-Block and Rings allow the shooter unparalleled versatility to mount nearly any popular handheld tactical light onto almost any weapons platform.



BLK

M-LOK TO MOE ADAPTER

MAG478 | **MSRP \$9.95**

The Magpul M-LOK to MOE Adapter Kit is designed specifically to adapt many M-LOK compatible accessories to Legacy MOE Hand Guards and Forends. The M-LOK to MOE Adapter plates are customizable to length by snapping sections off at the pre-determined locations which help ensure a near seamless installation. Adapter plates of various sizes and all replacement hardware are included.



BLK

T-NUT REPLACEMENT SET

MAG615 | **MSRP \$5.95**

The M-LOK T-Nut Replacement Set is a hardware set designed for use with all M-LOK accessories. Made of 4140 Chromoly steel with a Mil-Spec Manganese Phosphate finish, the hardware set is supplied with two different length button-head socket cap screws to ensure compatibility with various hand guard or forend thicknesses. A self locking reusable thread patch is added to the screws to ensure a secure fit upon installation.



BLK

MAG SL

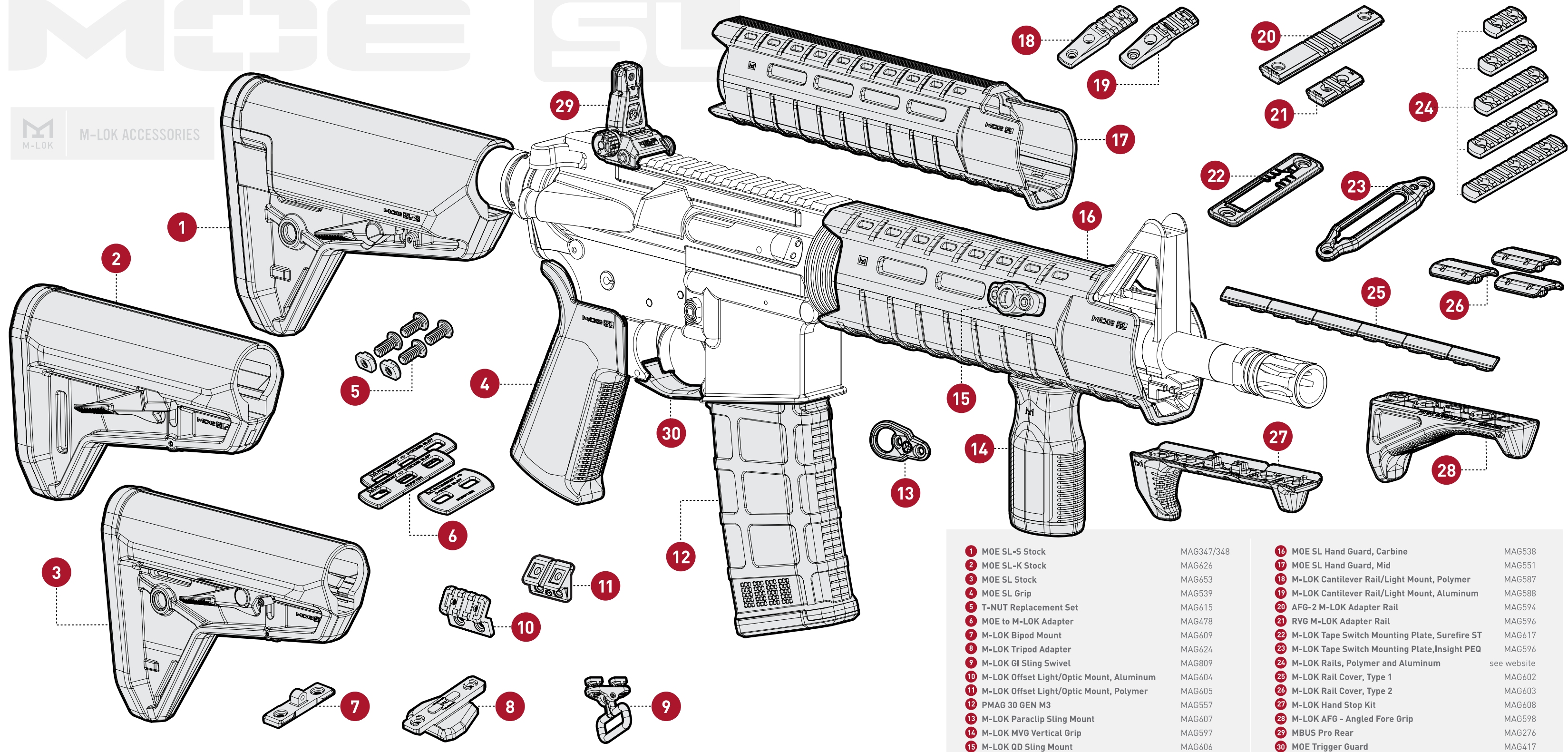
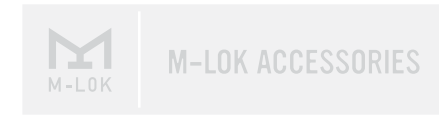

- | | | | | | |
|----|--|------------|----|---|-------------|
| 1 | M-OE SL-S Stock | MAG347/348 | 16 | M-OE SL Hand Guard, Carbine | MAG538 |
| 2 | M-OE SL-K Stock | MAG626 | 17 | M-OE SL Hand Guard, Mid | MAG551 |
| 3 | M-OE SL Stock | MAG653 | 18 | M-LOK Cantilever Rail/Light Mount, Polymer | MAG587 |
| 4 | M-OE SL Grip | MAG539 | 19 | M-LOK Cantilever Rail/Light Mount, Aluminum | MAG588 |
| 5 | T-NUT Replacement Set | MAG615 | 20 | AFG-2 M-LOK Adapter Rail | MAG594 |
| 6 | M-OE to M-LOK Adapter | MAG478 | 21 | RVG M-LOK Adapter Rail | MAG596 |
| 7 | M-LOK Bipod Mount | MAG609 | 22 | M-LOK Tape Switch Mounting Plate, Surefire ST | MAG617 |
| 8 | M-LOK Tripod Adapter | MAG624 | 23 | M-LOK Tape Switch Mounting Plate, Insight PEQ | MAG596 |
| 9 | M-LOK GI Sling Swivel | MAG809 | 24 | M-LOK Rails, Polymer and Aluminum | see website |
| 10 | M-LOK Offset Light/Optic Mount, Aluminum | MAG604 | 25 | M-LOK Rail Cover, Type 1 | MAG602 |
| 11 | M-LOK Offset Light/Optic Mount, Polymer | MAG605 | 26 | M-LOK Rail Cover, Type 2 | MAG603 |
| 12 | PMAG 30 GEN M3 | MAG557 | 27 | M-LOK Hand Stop Kit | MAG608 |
| 13 | M-LOK Paraclip Sling Mount | MAG607 | 28 | M-LOK AFG - Angled Fore Grip | MAG598 |
| 14 | M-LOK MVG Vertical Grip | MAG597 | 29 | MBUS Pro Rear | MAG276 |
| 15 | M-LOK QD Sling Mount | MAG606 | 30 | M-OE Trigger Guard | MAG417 |

HAND GUARDS

HAND GUARD & RAIL ACCESSORIES





MOE SL HAND GUARDS

MAG538 | **MSRP \$34.95** | CARBINE-LENGTH
MAG551 | **MSRP \$39.95** | MID-LENGTH

The MOE SL Hand Guards for AR15/M4 firearms for both carbine and mid-length gas systems provide modular flexibility with M-LOK accessory slots in a lightweight, slim line, cost effective design. Designed with versatility in mind, slots at the two, six, and ten o'clock positions allow the attachment of optional Picatinny rail sections and other direct attach accessories for the mounting of tactical lights, slings, grips, etc. Reinforced, heat-resistant polymer construction provides operational durability without the weight and expense of an aluminum rail hand guard. Large front extensions and lower lip provides additional operator protection from hot front sight assembly. For use with A2 fixed front sight assembly.



MOE **M-LOK**

BLK | FDE | ODG | GRY

MOE M-LOK HAND GUARDS

MAG424 | **MSRP \$29.95** | CARBINE-LENGTH
MAG426 | **MSRP \$34.95** | MID-LENGTH
MAG427 | **MSRP \$39.95** | RIFLE-LENGTH

MOE Hand Guards are drop-in replacements for the standard AR/M4 plastic hand guards, with M-LOK slots at the two, six, and ten o'clock positions for mounting rail sections and accessories. Designed for use with piston and direct impingement gas systems, MOE Hand Guards combine the light weight and simplicity of a standard hand guard with improved modular flexibility. Available in rifle, mid, or carbine-length models, the reinforced polymer construction provides operational durability without the weight and cost of an aluminum railed hand guard. The front extension provides additional grip length and shields the operator from hot front sight assembly.



MOE **M-LOK**

BLK | FDE | ODG | GRY



RAIL LIGHT MOUNT

MAG498 | **MSRP \$29.95** | RIGHT & LEFT SIDE MODEL | 1913 PICATINNY RAILS

Constructed of reinforced polymer, the Rail Light Mount nearly eliminates light compatibility concerns by accommodating Surefire 300 and 600 series Scout Lights, 1913 Picatinny attachment pistol lights, and all light bodies from 0.75" to 1.035" in diameter via the included V-Block and Rings. The mount fits on standard 1913 Picatinny Rail, is available in right or left side models, and integrates with the Magpul XTM panels. It positions the weapon light high and cantilevered forward, at the 11 o'clock or 1 o'clock position. A textured thumb ramp provides the user an index point for consistent hand placement and light activation.



BLK



XTM ENHANCED RAIL PANELS

MAG510 | **MSRP \$7.95** | 4-PACK | 913 PICATINNY RAIL

The XTM Enhanced Rail Panels are low-profile, two-piece covers that attach anywhere on a 1913 Picatinny rail without having to remove previously-mounted accessories. Replacing the original XTM Panels, the Enhanced XTM Panels feature an aggressive anti-slip texture and dual-side routing clips for retention of light/laser cables. The design and reinforced material construction ensure the panels will remain in place under all operating conditions, but allows for easy removal using the tips of two rounds when necessary. One eight-piece package will make four panels that cover one side of a carbine-length rail.



BLK | FDE | ODG | GRY | PNK





SIGHTS

Whether used as a primary sighting system or as a backup to an optic, the “iron” sight is a critical component for any rifle. The MBUS line of rail-mounted sights is expanding to provide solutions for every user. The MBUS continues to provide value and durability with polymer construction, while the MBUS Pro provides the absolute slimmest profile available combined with the strength of Melonited steel and tool-less adjustments. The MBUS Pro line has expanded from the standard 12 o’clock mounted folding back up sights, to our 45 degree MBUS Pro Offset sighting solution. For the match/precision shooter we offer the MBUS Pro LR, which gives shooters tool-less elevation adjustment for target engagement at variable ranges in the same low profile folding package as the MBUS Pro. Beginning in 2017 the MBUS Pro Enhanced Front Sight Post will be a standard on all MBUS Pro front sights, giving the end user the choice of a standard post for maximum visibility or a match post for increased precision.





MBUS FRONT

MAG247 | **MSRP \$39.95** | 1913 PICATINNY RAIL
NSN: 1005-01-591-8130 (BLK)

The MBUS (Magpul Back-Up Sight) is a low-cost, injection molded, folding back-up sight. The MBUS Front Sight is adjustable for elevation, features a built-in spring-loaded front sight post detent, and fits all Milspec 1913 Picatinny rail-equipped weapons, but is specifically tailored to the AR15/M4 platform. Front sight adjustment tool and all mounting hardware included.

Note: Due to the nature of polymer construction, the MBUS is not compatible with railed gas blocks and must be mounted to a railed forend.



MBUS REAR

MAG248 | **MSRP \$57.95** | 1913 PICATINNY RAIL
NSN: 1005-01-591-6150 (BLK)

The MBUS (Magpul Back-Up Sight) is a low-cost, injection molded, folding back-up sight. The dual-aperture MBUS Rear Sight is adjustable for windage, and fits all Milspec 1913 Picatinny rail-equipped weapons, but is specifically tailored to the AR15/M4 platform.



MBUS PRO FRONT

MAG275 | **MSRP \$84.95** | 1913 PICATINNY RAIL

The MBUS Pro is a corrosion resistant all-steel back-up sighting solution that delivers maximum functionality and strength with minimum bulk at a price that's even smaller than its size. The no-tool, elevation adjustable front sight excels in all 1913 Picatinny rail mounting applications, including rail-height gas blocks. Positive detents keep the MBUS Pro Front at standard AR sight height when deployed, and so low when they are stowed that you'll never notice them until they're needed. The narrow width front is compatible with most IR aiming laser and light installations for the professional user.



MBUS PRO REAR

MAG276 | **MSRP \$104.95** | 1913 PICATINNY RAIL

The MBUS Pro is a corrosion resistant all-steel back-up sighting solution that delivers maximum functionality and strength with minimum bulk at a price that's even smaller than its size. The dual aperture, windage adjustable rear sight is contoured to fit seamlessly on the tail end of AR15/M4 receiver 1913 Picatinny rails to avoid charging handle interference. Positive detents keep the MBUS Pro Rear at standard AR sight height when deployed, and so low when they are stowed that you'll never notice them until they're needed.



MBUS PRO OFFSET FRONT

MAG525 | **MSRP \$84.95** | 1913 PICATINNY RAIL

Building on the proven MBUS Pro platform, the MBUS Pro Offset Front Sight is part of an effective aiming system to supplement magnified optics on 1913 Picatinny mounting surfaces. In the event of a damaged or nonfunctional primary optic, or a close target, rotating the rifle 45 degrees provides the shooter with a fully-featured iron sighting solution. The MBUS Pro Offset Front Sight features durable Melonited steel construction, positive detented lockup when deployed, tool-less adjustment of the front post for easy zeroing, and a low profile footprint to ensure compatibility and reduce interference with most rifle setups.

BLK



MBUS PRO OFFSET REAR

MAG526 | **MSRP \$104.95** | 1913 PICATINNY RAIL

Building on the proven MBUS Pro platform, the MBUS Pro Offset Rear Sight is part of an effective aiming system to supplement magnified optics on 1913 Picatinny mounting surfaces. In the event of a damaged or nonfunctional primary optic, or a close target, rotating the rifle 45 degrees provides the shooter with a fully-featured iron sighting solution. The MBUS Pro Offset Rear Sight features durable Melonited steel construction, positive detented lockup when deployed, tool-less windage adjustment for easy zeroing, dual rear apertures, and a low profile footprint to ensure compatibility and reduce interference with most rifle setups.

BLK



MBUS PRO LR

MAG527 | **MSRP \$129.95** | 1913 PICATINNY RAIL

The new MBUS Pro LR capitalizes on the low profile and sleek styling of the original MBUS Pro, while adding the additional feature of elevation adjustments to accurately engage targets at variable distances. Built with all steel construction, this is the sighting solution that delivers no-tool adjustments, maximum strength, corrosion resistance, and functionality in a compact package. Positive detents keep the MBUS Pro LR at standard AR sight height when deployed and so low when stowed that you will hardly notice them.

BLK



MBUS PRO ENHANCED FRONT SIGHT POST

MAG553 | **MSRP \$9.95** | MBUS PRO & MBUS PRO OFFSET FRONT SIGHTS

The MBUS Pro Enhanced Front Sight Post is an upgrade for older MBUS Pro and MBUS Pro Offset Front Sights. Featuring a rectangular cross-section, the MBUS Pro Enhanced Front Sight Post offers the user the option of a 0.040" Match profile for precision shooting or a standard 0.060" profile for visibility without changing posts. Simply raise the post until it spins freely and rotate 90-degrees to present the other sight profile, then lower the post to its original position and confirm zero. The Match width side of the post has a marking dimple for easy identification during installation. Precision machined of alloy steel, the sight post features a Mil-Spec manganese phosphate finish for corrosion resistance and abrasion protection.

MATCH

STANDARD



BLK



CONFIGURING THE MS1 SLING

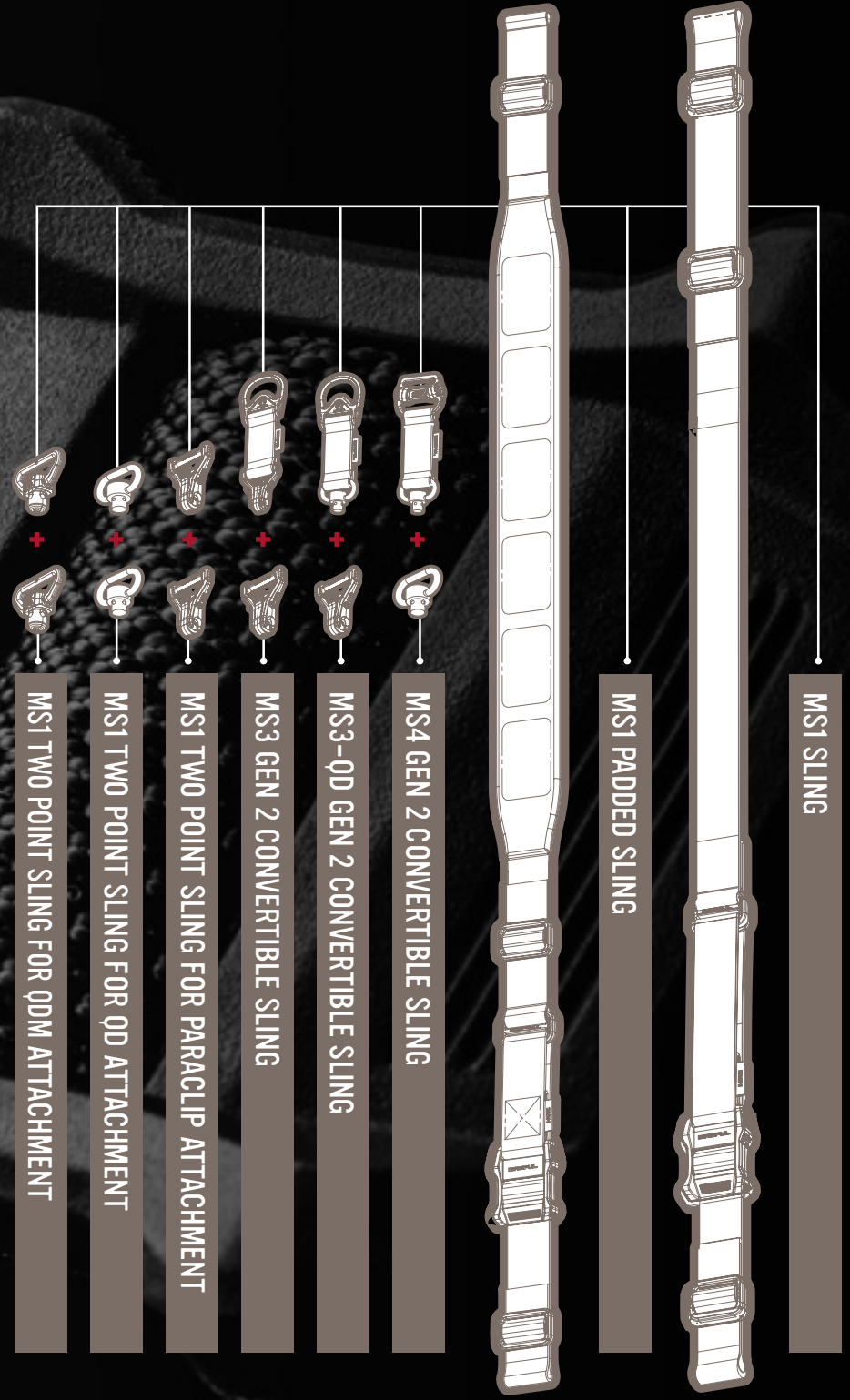

SLINGS

MAGPUL

IN 2014, WE INTRODUCED THE MS1. THE CONCEPT WAS SIMPLE, TO BRING A TRUE MULTI-MISSION SLING TO THE INDUSTRY.

The MS1 Sling System takes the multi-mission sling concept to new levels of function, capability, and modularity. The entire system is based on the MS1, a dedicated two-point sling built around our innovative new slider, which provides rapid sling adjustments without the tails, loops, or bulk of other solutions. Even while wearing gloves, the new slider is faster, easier, and lower profile, and your sling setting stays put, even under load. The MS1 is also one-point configurable by simply adding the appropriate one-point adapter that works with your choice of hardware. Additionally, for out-of-the package one-point capability, the MS3, MS3-QD, and MS4 slings are now shipping with the MS1 as the basis of their construction, with all necessary adapters and attachments included. The new MS1 Padded offers all of the same comforts of a padded sling with none of the failure points. By using a single piece of hollow variable width webbing, we have eliminated the need to stitch a section of pad onto or around the sling. By using highgrade foam for the padded insert, you can rest assured that it won't absorb moisture. The pad is also held in place with a unique stitching pattern that ensures it will never shift or bunch up in the webbing. In 2015 we introduced the QDM, an improved quick detach sling swivel option that offers more strength and durability than other traditional push-button QD attachments. Slings are available in Black, Coyote, Ranger Green and Gray.

The MS1 Sling System: One sling to meet all missions.





Single piece variable-width tubular webbing.

MS1 SLING

MAG513 | **MSRP \$34.95** | MULTI-MISSION SLING SYSTEM

The MS1 sling is the most versatile addition to the Magpul line of rifle slings. This sling system starts with an optimized, dedicated two-point sling that serves equally well in a one-point role when using optional adapters. Based on our MS1 slider, this system provides rapid adjustments to either lengthen or shorten the sling with no slipping once set, and no tails, loops, or other potential snag hazards. In a two-point role, the MS1 allows easy shoulder transitions, rapid adjustability for hands free rifle carry and shooting support from various positions. The MS1 system also has a series of adapters that are sold separately and based on the MS3 and MS4 slings. By adding the appropriate adapter (available in Paraclip or QD) for the sling, you can easily add one-point function to your MS1.

In testing, the sling had to survive tens of thousands of cycles in wet, dry and sandy conditions, static load testing without slippage for 72 hours and weighted 6 foot dynamic drop tests. In addition to the controlled lab tests, we also swam it, jumped it, hunted with it, hiked into the mountains with it, and most importantly shot with it in a variety of rugged field conditions.



MS1 PADDED SLING

MAG545 | **MSRP \$59.95** | MULTI-MISSION SLING SYSTEM

The MS1 Padded Sling is the latest addition to the Magpul line of rifle slings. By adding a padded section of variable-width tubular webbing to the already proven MS1 sling, this new product provides more comfort to the user when carrying heavy weapons. Other padded slings simply sew the pad onto or around an already existing sling. What we have done is taken a section of variable-width webbing of our proprietary weave and stitched a high-grade, ripstop coated, foam pad to the inside of the sling. This ensures that the pad will never move inside of its housing and because the taper of the sling is woven, not stitched, the padded section has no known points of failure. By removing the structural stitching from padded slings, we have created a sleek and streamlined solution that exceeds all others in durability and aesthetics.

This sling system starts with an optimized, dedicated two-point sling that serves equally well in a one-point role when using optional adapters. Based on our MS1 slider, this system provides rapid adjustments to either lengthen or shorten the sling with no slipping once set, and no tails, loops, or other potential snag hazards. In a two-point role, the MS1 allows easy shoulder transitions, rapid adjustability for hands free rifle carry and shooting support from various positions. The MS1 system also has a series of adapters that are sold separately and based on the MS3 and MS4 slings. By adding the appropriate adapter (available in Paraclip or QD) for the sling, you can easily add one-point function to your MS1.



MS1 MS3 ADAPTER

MAG516 | **MSRP \$15.95**

- Combine with MS1 Sling and Paraclip (MAG541) to provide 2-1 Point convertibility
- Melonite finished steel and reinforced polymer construction
- Custom snag-free high-durability 1-1/4" webbing



MS1 MS3-QD ADAPTER

MAG517 | **MSRP \$20.95**

- Combine with MS1 Sling and Paraclip (MAG541) to provide 2-1 Point convertibility
- Manganese-phosphate finished steel and reinforced polymer construction
- Custom snag-free high-durability 1-1/4" webbing



MS1 MS4 ADAPTER

MAG519 | **MSRP \$24.95**

- Combine with MS1 Sling and QD Swivel (MAG540) to provide 2-1 Point convertibility
- Melonite and manganese-phosphate finished steel and reinforced polymer construction
- Custom snag-free high-durability 1-1/4" webbing



QD SLING SWIVEL

MAG540 | **MSRP \$14.95**

- Push-button quick-detach sling swivel for 1-1/4" webbing
- Manganese-phosphate finished steel
- Compatible with QD sling attachment points



PARACLIP

MAG541 | **MSRP \$9.95**

- Clip-style sling attachment point for 1-1/4" webbing
- Lockable
- Melonite finished steel and reinforced polymer construction
- Compatible with ASAP Plate, RSA, MSA, M-LOK Paraclip Sling Mount and other clip-in sling attachment points



QD PARACLIP ADAPTER

MAG542 | **MSRP \$15.95**

- Adapts standard QD sockets for use with Paraclips and other clip-in sling attachments
- Precision-cast Melonite finished steel





QDM-QUICK DISCONNECT SLING MOUNT

MAG543 | MSRP \$27.95

The Magpul QDM is a Melonited, heavy duty upgrade to standard push-button QD sling swivels. The innovative design allows for a lower profile sling swivel that offers one-handed manipulation, an optimized bale that rotates freely and canalizes rifle slings to prevent rollover, and superior resistance to corrosion. The QDM has a breaking strength nearly double that of conventional QDs. Is compatible with 1.25" webbing and push-button QD swivel sockets.

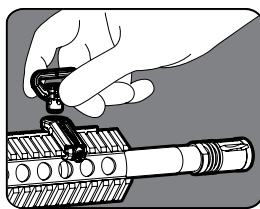

TO ATTACH QDM TO MOUNT
Grip actuation surfaces with finger/thumb and push into socket.

BLK



MS3 GEN2 SLING

MAG514 | MSRP \$49.95

Optimized for use with the ASAP and RSA or MSA and M-LOK QD Sling Mount the MS3 can switch quickly between one-point and two-point configuration. Made from custom nylon webbing chosen for its comfort and strength, and now with the MS1 slider, the MS3 is easily adjustable for shooter size and preference. It also features a light weight, heavy duty, polymer and steel Paraclip to allow easy manipulation in emergency situations.



BLK | COY | RGR | GRY



MS3 SINGLE QD GEN2 SLING

MAG515 | MSRP \$57.95

Filling the same mission requirement as the standard MS3, and now with the MS1 slider, the MS3-QD can quickly switch between one-point and two-point configuration. The MS3-QD maintains material construction and specifications identical to that of the standard MS3, but features a heavy duty push-button QD sling swivel for the one-point (rear) weapon attachment rather than the Magpul Paraclip found on the standard MS3. This modification allows compatibility with QD sling cups commonly found on lower receivers, receiver end plates, and buttstocks.



BLK | COY | RGR | GRY



MS4 DUAL QD GEN2 SLING

MAG518 | MSRP \$59.95

The MS4 Sling is a Dual QD version of the standard MS3 Sling. With push-button QD Sling Swivels in place of the standard Paraclips, and now with the MS1 slider, the MS4 provides a two to one-point convertible sling option compatible with front and rear QD attachment points.



BLK | COY | RGR | GRY



PRS QD FOOTMAN'S LOOP

MAG628 | **MSRP \$29.95**

Originally made for a DoD contract, the PRS QD Footman's Loop is a machined aluminum replacement sling mount for the original PRS Stock. Featuring a 1.25" footman's loop for direct attachment of webbing as well as an integrated push-button QD swivel socket, the PRS QD Footman's Loop is easily installed and adds a new degree of sling mounting versatility to your precision rifle platform.



BLK **NEW PRODUCT**

RSA RAIL SLING ATTACHMENT

MAG502 | **MSRP \$29.95** | 1913 PICATINNY RAIL

The RSA provides a forward sling attachment point for the Magpul MS3 and other clip-in sling systems. Made from Melonite finished, precision cast steel, the RSA attaches to 1913 Picatinny rails.



BLK

ASAP-QD

MAG529 | **MSRP \$29.95**

The ASAP-QD Ambidextrous Sling Attachment Point replaces the standard AR15/M4 carbine stock receiver end plate, facilitating easy transitions from primary to secondary side shoulders. The ASAP-QD works with all push-button QD sling swivels, and is canted slightly downward for greater freedom of movement and to create a finished look to the end of the receiver. Made from precision cast Melonite finished steel, the ASAP-QD is compatible with both mil-spec and commercial-spec carbine receiver extensions (buffer tubes).



BLK

ASAP

MAG500 | **MSRP \$29.95**

A replacement for the standard AR/M4 carbine receiver end plate, the ASAP is a truly ambidextrous rear sling attachment point that provides over 180 degrees range of motion, allowing efficient transition from primary to secondary shoulders. Made from Melonite finished steel, the ASAP replaces the standard carbine receiver end plate and is compatible with both mil-spec and commercial-spec receiver extensions (buffer tubes).



BLK

MSA-QD MOE SLING ATTACHMENT

MAG528 | **MSRP \$19.95** | MOE HAND GUARDS & FORENDS

The MSA-QD provides a rotation-limited forward attachment point for push-button QD slings on all Magpul MOE Hand Guards and Forends. Made from precision cast Melonite finished steel, the MSA-QD mounts with minor user modification.*

*MOE accessory slot needs to be enlarged by user to allow installation. Instructions included.



MOE

BLK

RSA-QD RAIL SLING ATTACHMENT

MAG337 | **MSRP \$29.95** | 1913 PICATINNY RAIL

The RSA-QD provides a forward attachment point for the Magpul MS4 Sling and other push-button QD slings. It is Melonite finished steel, mounts on 1913 Picatinny rails, and places the attachment point at an angle optimized for comfortable two-point sling use while maintaining easy push-button access. Features rotation limiting technology.



BLK

TOOLS

PROFESSIONAL GRADE TOOLS FOR A LIFETIME OF SERVICE.

The Magpul Armorer's tools were purpose designed and built to provide our armory with products that would stand up to the volume of use that other tools could not sustain, as well as provide optimized functionality for the tasks it had to perform. The cost and lost time of breaking tools at an unacceptable rate led to our armorers asking the company to apply our proven design and manufacturing expertise to help solve their problem, and the Magpul Armorer's Wrench and BEV Block were the result. While the cost was slightly higher than some other armorer's tools, the function and durability more than offset the cost difference. Once the wrench and BEV Block proved its worth in our shop, the tools transitioned to a production item with a singular goal made possible by its many functions: to provide the professional, institutional, or recreational armorer's the finest commercially available AR15-pattern tool ever produced.



SPEEDTHREADER

MAG220 | **MSRP \$10.95** | MOLLE/PALS WEBBING
NSN: 8465-01-565-4798

Designed to dramatically improve the speed and ease of configuring MOLLE/PALS webbing. This device clips onto the strap of a modular pouch and guides it smoothly through the vest webbing for hassle-free interlacing. Speed Threader can attach a two-strap pouch (interlaced correctly) in about 60 seconds.

BLK



BEV BLOCK

MAG536 | **MSRP \$49.95** | AR15/M4

The BEV Block (Barrel Extension Vise) is an all-in-one, compact vise block tool for AR assembly operations of barrel nuts, flash hiders, etc. Mounts securely in a vise and provides support for both billet and forged upper and lower receivers. Engages barrel extension with solid steel lugs and full length support shank to prevent flexing. Steel hardness is optimized for durability yet won't damage barrel extension, and Magpul Polymer for all other engagement surfaces to protect aluminum receiver. O-ring post uses bolt carrier for additional stability and included Pin keeps upper in proper position.

BLK



ARMORER'S WRENCH

MAG535 | **MSRP \$79.95** | AR15/M4

American-Made, solid steel construction with grip-enhancing phosphate finish engages both mil-spec and pin-style barrel nuts. Fits standard sized flash hiders. Installs and removes rifle receiver extensions and carbine castle nuts, with extended teeth for use with ASAP plates. Two hammer faces. Works with 1/2" torque wrench, relevant torque specifications included on Wrench for quick reference. Convenient Bottle Opener for refreshments after the build is complete (fits both Metric and SAE bottle caps.)

BLK





ACCESSORIES

When we look at the human interface of the firearm, our goal is to improve the functionality and performance in every area. We pay attention to the little things, striving to give the user every unfair advantage.



ENHANCED AR MAGAZINE RELEASE

MAG568 | **MSRP \$19.95** | AR15/M4

Machined from mil-spec anodized aluminum this two-piece, easy to install magazine release gives the user a larger contact surface for positive activation. The Enhanced Magazine Release is compatible with most 5.56 and 7.62 pattern receivers.



BLK



MOE TRIGGER GUARD

MAG417 | MSRP \$8.95

The MOE Trigger Guard is an economical, drop-in polymer replacement for AR15/M4 trigger guards, designed to provide increased clearance for use with gloves, and to eliminate the annoying gap at the rear of the mil-spec trigger guard.



MOE

BLK | FDE | ODG | GRY

ENHANCED TRIGGER GUARD

MAG015 | MSRP \$19.95

The Magpul Enhanced Trigger Guard is a drop-in aluminum replacement for AR15/M4 trigger guards, designed to provide increased clearance for use with gloves. It eliminates the annoying gap at the rear of standard trigger guards.



BLK



B.A.D. LEVER

MAG980 | MSRP \$29.95 | MIL SPEC FORGED RECEIVERS
NSN: 1005-01-591-6130

The B.A.D. Lever (Battery Assist Device) is designed to considerably improve the speed and efficiency of the AR15/M4 bolt catch. The B.A.D. Lever quickly addresses reloading and malfunction clearance shortcomings of AR15/M4 platforms by extending a paddle to the right side of the weapon, allowing manipulation of the bolt stop from the fire control/ready position with the right-hand trigger finger.

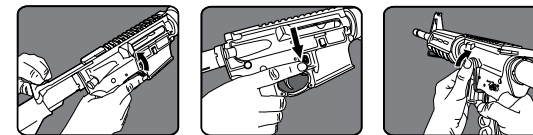

BOLT CATCH (1) To lock the bolt carrier to the rear using the B.A.D. Lever, place your right hand trigger finger under the paddle of the B.A.D. Lever, while taking care not to enter the trigger well. Apply upward pressure, while pulling the charging handle to the rear, until the bolt catch engages the bolt face.

BOLT RELEASE (2) To release the bolt, place your right hand trigger finger on top of the paddle and press downward, taking care to keep your finger out of the trigger well.

BLK



SSG SELECTOR SET

MAG499 | MSRP \$19.95 | SCAR MK16(S) & MK17(S)

The Magpul SSG Selectors are drop-in, dual-sided selectors for the FN SCAR family of weapons. Designed at the request of a deploying military unit who wanted more positive control of the selector, the SSG are compatible with military-issue select fire MK16 & MK17 weapons, as well as the civilian semi-automatic SCAR 16S & 17S rifles. The SSG are direct replacements for the OEM selectors, and require no permanent modification to the weapon system. Simple install utilizing existing set screw (not supplied).



BLK

GEAR

2017 marks our second year developing apparel and accessories, giving all the same attention to detail that is given to our firearms products. This year we took a deeper look into some of the simpler things to better them for our needs.

Our DAKA collection of pouches and personal gear extend the benefits of efficiency through organization to the wet, dusty and dirty world we work and play in. Something as simple as a belt can benefit from the principals of innovation and careful design, teaching us that what makes a great gun belt, makes a great belt. Items sometimes considered generic, like hats and t-shirts, can benefit the most from the extra effort and engineering we believe you will see and feel.

All of the gloves, belts, apparel, headwear and accessories under the Magpul name follow the same strict design, material construction, and manufacturing principles that you have come to depend on and always will.



MAGPUL DAKA POUCHES

- MAG856 | **MSRP \$18.95** | SMALL
- MAG857 | **MSRP \$22.95** | MEDIUM
- MAG858 | **MSRP \$27.95** | LARGE
- MAG859 | **MSRP \$34.95** | X-LARGE

The Magpul DAKA Pouch, designed to bring organization to the dusty, dirty, and muddy world we work and play in. Made from polymer infused textiles that are welded on all seams and use a genuine YKK® water resistant zipper. The construction methods and materials used mean that these pouches are at home in hard use applications like tool storage or bulk storage of your reloaded ammunition as well as lighter duties like organizing your personal electronic accessories. Although these pouches are not 100% water proof (read submersible...) they will keep your items dry under most wet weather situations making them a great choice for most outdoor adventures.



MAGPUL DAKA WINDOW DOCUMENT POUCH

- MAG894 | **MSRP \$39.95**

Sized in between the large DAKA and the XL DAKA, the window document pouch is constructed with a new form factor that allows vertical insertion of documents. It includes a fully sealed transparent window area to see the contents and allows you to manipulate many touch screen devices.



MAGPUL DAKA SUPPRESSOR POUCHES

- MAG875 | **MSRP \$17.95** | SMALL
- MAG876 | **MSRP \$21.95** | MEDIUM
- MAG877 | **MSRP \$25.95** | LARGE

Constructed the same as our original DAKA pouches, the newest models are size optimized for storage of firearm sound suppressors and their accessories. Rugged and easy to clean, they are ideal for storage or transport of your suppressor along with your NFA paperwork. Available in three sizes to accommodate rimfire through 7.62 rifle cans.



MAGPUL DAKA EVERYDAY WALLET

- MAG763 | **MSRP \$24.95**

Designed in the spirit of our original DAKA wallets, the "Everyday wallet" is for those who want just a little more room while still taking advantage of the slim, seamless utility of our essential wallet. Sized slightly larger, and now featuring a windowed ID pocket with a convenient center divider pocket for your bills and notes.



MAGPUL DAKA ESSENTIAL WALLET

- MAG758 | **MSRP \$16.95**

The Essential Wallet is an extension of our Magpul DAKA collection. Made to hold only the cards that are essential to your daily life in one convenient place, eliminating the bulk and clutter of unnecessary cards. The single pocket logo side is used to hold up to four ID/access cards and the dual pocket in the back is used to hold up to three credit cards in the top pocket and up to four emergency bills folded in the lower pocket.



MAGPUL DAKA MICRO WALLET

- MAG762 | **MSRP \$9.95**

The Magpul DAKA Micro Wallet is the lightest and thinnest in the Magpul DAKA Wallet collection. We built the toughest, thinnest wallets in the world because you're already carrying too much stuff.



MAGPUL DAKA LUGGAGE TAG

- MAG778 | **MSRP \$14.95**

The Magpul DAKA Luggage Tag, an extension of our Magpul DAKA collection. Made from the same reinforced polymer fabric as our popular DAKA pouches.



TEJAS GUN BELT

TEJAS GUN BELTS

The Tejas Gun belt line started with the idea that you shouldn't have to wait months for a custom gun belt, or pay more for something that doesn't live up to the gun belt task. Our approach has been to apply the traditional leather crafting techniques available to us here in Texas, combining that with modern materials and manufacturing methods, to create what we believe to be the best gun belts available. What we found out was that by doing this we were not just making a great gun belt.. we were making a great belt.



CONSTRUCTION

Each of the styles in our Tejas gun belt line feature individual strap constructions engineered for the specific uses of each style.

El Original uses a top grade bullhide leather exterior and supportive but flexible reinforced polymer interior that make it a perfect all-purpose gun belt.

The El Burro our all-purpose, all conditions belt is built of a single flexible layer of waterproof, textured, reinforced polymer material.

For a dressier look, the El Impresario is a slightly thinner package of full aniline leather exterior and supportive but flexible reinforced polymer interior.



HARDWARE

All El Original Gun Belts have a removable chrome plated buckle with our own "tool-free" fasteners. El Burro uses a corrosion resistant aluminum buckle and hardware that is removable with a simple twist of a 3/16" hex wrench. The suit appropriate El Empresario features a thinner buckle design and our same "Tool Free" fasteners all Tejas Gun Belts allow you to change your hardware or upgrade any belt that uses a standard 1.25" or 1.5" buckle and two removable screws.



LAYERS

Eight holes with a narrower 3/4" spacing for a wide yet precise adjustment range.

Multiple lengths available from 32-44 inches.



GEAR

"EL EMPRESARIO"

MAG779 | **MSRP \$89.95** | 32, 34, 36, 38, 40, 42, 44

NEW PRODUCT

The "El Empresario," a new addition to the Magpul Tejas Gun Belt line, is crafted from specially selected full aniline leather, hand milled and drum dyed. Like the original Tejas gunbelt this full grain outer layer is backed by a supportive but flexible reinforced polymer. Cut to a narrower 1 1/4" width and just slightly thinner overall, it maintains the gun belt rigidity with dress belt looks and comfort. Still rigid enough to carry a holster, but with increased comfort for everyday use while retaining it's stretch and sag free performance.



"EL ORIGINAL" 1.25 INCH

MAG831 | **MSRP \$84.95** | 32, 34, 36, 38, 40, 42, 44

NEW PRODUCT

Similar to our first Tejas Belt, the "El Original", this 1.25" variant is for those who desire a slighter slimmer version that can still handle the weight of a full size pistol. Crafted from a combination of inch-and-a-quarter wide top grade bullhide leather and reinforced polymer, it's strong and water resistant, rigid enough to carry a holster, but still comfortable for everyday use.



"EL ORIGINAL" 1.5 INCH

MAG733 | **MSRP \$84.95** | 32, 34, 36, 38, 40, 42, 44

"El Original" is the first belt in the Tejas Gun Belt line by Magpul. Crafted from a combination of inch-and-a-half wide top grade bullhide leather and reinforced polymer, it's strong and water resistant, rigid enough to carry a holster, but still comfortable for everyday use.



"EL BURRO"

MAG755 | **MSRP \$59.95** | 32, 34, 36, 38, 40, 42, 44

The "El Burro". Our all purpose, all the time belt. Using 100% reinforced polymer construction and all non-ferrous custom hardware, this beast of burden is what you want to be wearing for those more "adventurous" moments in life.



TEJAS BELT HARDWARE KIT

MAG754 | **MSRP \$12.95**

Using the same high quality hardware that comes on our Tejas "El Original" Gun Belt, this hardware kit allows you to change the color of your hardware or upgrade any belt that uses a standard 1-1/2" buckle and two removable screws.



MAGPUL CORE GLOVES

BREACH GLOVES

MAG855 | **MSRP \$69.95** | S, M, L, XL, 2XL

The Magpul Core Breach Gloves are designed to preserve comfort and dexterity when manipulating weapons, tools and specialty equipment while providing the highest level of protection to the user. Hard knuckle armor and digital pattern reinforced leather palms combine with touch screen capability and articulated hand and finger construction for maximizing protection without sacrificing 'feel'.



BLACK (001) | COYOTE (251) | CHARCOAL (010)

FR BREACH GLOVES

MAG852 | **MSRP \$119.95** | S, M, L, XL, 2XL

The FR Breach Gloves are the most protective hard-use gloves in the Magpul line up. They incorporate the hard knuckle armor, digital pattern reinforced leather palms and touch screen capability of our standard breach glove and adds the FR protection of Nomex® and Kevlar®.



BLACK (001)

FLIGHT GLOVES

MAG850 | **MSRP \$59.95** | S, M, L, XL, 2XL

Built on the tradition of the first Nomex® flight gloves worn by military aviators since the 1960's, the new Magpul Flight Gloves use modern materials, fit and finish to provide comfort, fire resistance and protection. Fitting like a second skin, these touchscreen capable gloves are at home inside the cockpit or out for all highdexterity tasks.



BLACK (001) | SAGE (342)

PATROL GLOVES

MAG851 | **MSRP \$44.95** | S, M, L, XL, 2XL

Every day, all day. The Magpul Core Patrol Gloves provide protection and durability in a package that remains comfortable even with extended use. Lightweight construction with one-piece, premium leather palm and reinforcement in all the right places for rugged comfort with the refinement of touchscreen capability.



BLACK (001) | COYOTE (251) | CHARCOAL (010)

TECHNICAL GLOVES

MAG853 | **MSRP \$24.95** | S, M, L, XL, 2XL

The most lightweight and tactile glove in the Magpul line up, our Technical Gloves offer abrasion protection with maximum dexterity. Durable synthetic construction for a second-skin fit with terry backed thumbs and touch screen capability that provide protection for active hands with minimum impact on fine motor skills.



BLACK (001) | COYOTE (251) | CHARCOAL (010)

RANCH GLOVES

MAG854 | **MSRP \$39.95** | S, M, L, XL, 2XL

Inspired by our appreciation of traditional things that just 'work', the Magpul Ranch Gloves are a modern interpretation of a classic. The Ranch Gloves feature a modern athletic fit, touchscreen enhancement and 100% goatskin leather construction for hard-working hands to feel at home.



TAN (211)

MAGPUL HEADWEAR

NEW PRODUCT

Starting from a clean sheet of paper, a new range of hats, designed and engineered by Magpul to become your new favorite. All are carefully crafted for comfort and durability, not just to be a carrier for a logo. With four very different styles, there is something for everyone in the newest Magpul hat collection.



MID CROWN SIXER

- + Mid crown profile with one solid fabric
- + Classic six panel construction
- + Breathable sweatband



MID CROWN TRUCKER

- + Mid crown profile
- + Softer more comfortable mesh
- + Breathable sweatband



LOW DOWN LOW CROWN

- + Low crown profile laid back and relaxed
- + Adjustable strap closure
- + Breathable sweatband



CORE COVER

- + Core cover is a low crown profile with stretch fit
- + Crushable with breathable fabric
- + No top button for hearing protection



MAGPUL APPAREL

NEW PRODUCT

At Magpul, our apparel isn't just tees and hoodies – 2017 marks the growth of multiple categories in our Everyday Wear apparel range. We've expanded our line from engineered t-shirts to include specially made and designed tops, bottoms and outerwear. All of the items within this collection are engineered with performance in mind. Using modern fabrics and fabric treatments, which are designed to be comfortable and effective during demanding activities. We included smart features that make a difference and avoided the temptation to include "add-ons," that look better on paper than they perform in the field.

Magpul Apparel, Everyday Wear, Everyday Where?

For more information on the full line of Magpul apparel please visit magpul.com/apparel



TOPS

- + Long Sleeve button ups, pull overs and work shirts
- + Short Sleeve warm weather styles
- + Performance Polos
- + Graphic Fleece and other cool weather styles



BOTTOMS

- + Pants for training, travel, work or casual wear
- + Shorts with rugged durability and warm weather performance



T-SHIRTS

- + Magpuls own cut-n-sew pattern engineering

FINE COTTON 100% Ring Spun Cotton

MEGABLEND 50% Cotton, 38% Poly, 12% Rayon

SUPERWEIGHT 100% Ring Spun 7.5 oz Superweight cotton Jersey



WOMENS

- + Medium weight performance Tees, tailored specifically for women

MEGABLEND 50% Cotton, 38% Poly, 12% Rayon



GEAR



PMAG D-60 DRUM POUCH

NEW PRODUCT

MAG651 | **MSRP \$64.95**

Designed as a companion accessory for our D-60 Drum Magazine, the D-60 Pouch offers a convenient way to carry, protect, and assist deployment of the drum. The form fitting pouch features an interior dust cover dummy cord attachment point, drainage system, and is collapsible when empty to minimize bulk. Attachment to all your PALS compatible gear is made with the two provided MALICE CLIPS®. Made in the USA.



COY



PATCHES, DECALS, POSTERS & STICKER PACKS

SEE WEBSITE FOR DETAILS & NEW DESIGNS

Our patches, stickers, and other propaganda material are constantly changing.

Please visit Magpul.com for current designs and pricing.

FIELD CASES

- MAG452 | **MSRP \$16.95** | FOR iPhone SE/5/5S
- MAG484 | **MSRP \$16.95** | FOR iPhone 6/6S
- MAG485 | **MSRP \$16.95** | FOR iPhone 6/6S PLUS
- MAG845 | **MSRP \$16.95** | FOR iPhone 7
- MAG849 | **MSRP \$16.95** | FOR iPhone 7 PLUS
- MAG488 | **MSRP \$16.95** | FOR GALAXY S6
- MAG780 | **MSRP \$16.95** | FOR GALAXY S7



The Field Case features a semi-rigid construction to allow snag-free removal from pockets, protection from minor impacts/drops, low profile PMAG-style side ribs for added grip, and single-piece snap-on design for easy installation and removal. Designed and manufactured in the U.S.A.

BLK | FDE | ODG | GRY | ORG | PNK



EXECUTIVE FIELD CASES

MAG472 | **MSRP \$16.95** | FOR iPhone SE/5/5S

The Magpul Executive Field Case for the iPhone SE is a slimline cover designed to provide basic protection in the field. Made from a flexible thermoplastic, the Executive Field Case features a slim and unobtrusive design, snaps-on for easy installation and removal, and slides easily in and out of pockets without snagging.



BLK | FDE | ODG | GRY | ORG | PNK



BUMP CASE iPhone

MAG486 | **MSRP \$26.95** | FOR iPhone 6/6S

The Bump Case features a semi-rigid construction to allow snag-free removal from pockets. Two-material construction combines a hard protective shell with an inner shock absorbing layer, low profile PMAG-style side ribs for added grip, and single-piece snap-on design for easy installation and removal. The Bump Case has the benefits of a rigid-shell/semi-rigid liner without adding unnecessary bulk. Designed and manufactured in the U.S.A.



BLK | FDE | ODG | GRY | ORG



KNOWLEDGE

THE MAGPUL BLACK BOOK SERIES, STARTING WITH THE PRECISION RIFLE QUICK REFERENCE CARDS AND DATA BOOK 2.0.

The Magpul Black Book Series is a collection of knowledge created to aid and enhance your experiences in the field. There will be an assortment of different modules covering a variety of military and practical field subjects. From shooting and tactics to survival, communications and physical training, there will be a module for everyone. The majority of the publications will be printed on a PVC material that will give the books true all-weather writing capability when using map pens and pencils, and will be conveniently sized to fit in standard uniform pockets and wrist boards.



PRECISION RIFLE DATA BOOK 2.0

DYN036 | MSRP \$49.95 | 5"W X 7"H

Previously available only through enrollment at a Magpul Core PR course, the Magpul Precision Rifle Data Book uses a simplified density altitude based, color-coded chart to record your rifles' data across a wide spectrum of shooting conditions. Using a rugged, all-weather material that can be written on using map pens, pencils, and non-permanent markers, this data book was designed to perform in austere conditions. Recorded data can also be erased with alcohol based substances, returning the material to its original state. All pages are reusable and include a field expedient density altitude calculator, cold bore shot tracking log, known distance data confirmation pages, range cards, a point of impact shift tracker, and simple hasty hold formulas. Ring not included.

- True all-weather, semi rigid writing surface
- Recorded material is erasable with alcohol
- Field Expedient Density Altitude calculator
- Cold Bore/Night Optic and POI Shift Track Logs
- KD Data collection sheets from -5000 to 16700 feet DA
- Field Range Cards and Unknown Distance/Observation Amplifying Remarks Cards
- Moving target and Hasty Hold Formulas

PRECISION RIFLE QUICK REFERENCE CARDS

DYN037 | MSRP \$19.95 | 5 1/8"W X 3 1/8"H

Previously available only through enrollment at a Magpul Core PR course, the Magpul Quick Reference Cards offer the shooter a comprehensive overview of the fundamentals of marksmanship, quick reference range estimation sheets, checklists for building shooting positions, aids for the observer, and aids for reading wind. Using the same density altitude system and rugged, all-weather, erasable material as the Precision Rifle Data Book, the Quick Reference Cards offer streamlined access to your rifles' elevation and wind data. Conveniently sized for use in an arm board, your data will always be within reach. Ring not included.

- True all-weather, semi rigid writing surface
- Recorded material is erasable with alcohol
- Mil based range estimation calculator
- Marksmanship fundamentals overview and Shooter/Observer Checklists
- KD Data sheets from -5000 to 16700 feet DA
- Wind Cues
- Reticle Hold Worksheet for BDC based reticles

Intended for use as a medium to transfer data for a given rifle from the PR Data Book to these cards for use in the field.



MAGPUL CORE

"The definition of adventure is to engage in exciting, and usually dangerous behavior, to plunge head first into the unknown and to rely only on one's self while negotiating the onslaught of hazard."

The mission of Magpul CORE is to project the founding principles of Magpul Industries Corporation to our customers, and provide a source of feedback to our design staff on the validity of new products. We do this through various activities such as firearms and adventure training courses, media and communication outlets, and presenting our lifestyle principals through examples of personal accountability, responsibility, and celebration of individual liberties.

Our staff is comprised of several subject matter experts who live lifestyles of adventure, and refuse to accept average as a way of life. These lifestyles take us to some of the most challenging and austere environments the world has to offer, which is the perfect test bed to evaluate our products in the most severe conditions.

2016 was an immense year for Magpul CORE. We took a small step back from firearms specific training courses and focused on testing and evaluating equipment, and capturing media in several corners of the world. Africa, Alaska, Baja, Costa Rica, and Nepal all proved to be rich with experience and valuable input, and have set the precedence for years to come.

Expect big things from Magpul CORE in 2017. With a resurgence in firearms and adventure training courses throughout the country, look for a course near you, and watch us continue to toe the line and push the limits.



2017 TRAINING COURSES

- LONG RANGE PRECISION RIFLE 1
- LONG RANGE PRECISION RIFLE 1 & 2 COMBO
- DESIGNATED MARKSMAN RIFLE
- PRECISION HUNTER
- BACKCOUNTRY HUNTER COURSE
- WILDERNESS NAVIGATOR *(NEW COURSE)*
- TACTICAL MOVEMENT AND CONCEALMENT *(NEW COURSE)*
- HANDGUN LEVELS 1 & 2
- CARBINE LEVELS 1 & 2



INDEX

ACCESSORIES	145
B.A.D. LEVER	148
ENHANCED AR MAGAZINE RELEASE	146
ENHANCED TRIGGER GUARD	147
MOE TRIGGER GUARD	147
SSG SELECTOR SET	148
BOLT ACTION	029
BOLT ACTION MAGAZINE WELL	034
BOLT ACTION MAGAZINE WELL 700L, MAGNUM	032
BOLT ACTION MAGAZINE WELL 700L, STANDARD	032
HUNTER 700	033
HUNTER 700L	031
PMAG 5 AC	034
PMAG 10 AC	034
PMAG 5 AC L, MAGNUM	032
PMAG 5 AC L, STANDARD	032
GEAR	149
BUMP CASES	162
FIELD CASE	145
EXECUTIVE FIELD CASE	162
MAGPUL APPAREL	159
MAGPUL CORE GLOVES	155
MAGPUL DAKA ESSENTIAL WALLET	152
MAGPUL DAKA EVERYDAY WALLET	152
MAGPUL DAKA LUGGAGE TAG	152
MAGPUL DAKA MICRO WALLET	152
MAGPUL DAKA POUCHES	151
MAGPUL DAKA SUPPRESSOR POUCHES	151
MAGPUL DAKA WINDOW DOCUMENT POUCHES	151
MAGPUL HEADWEAR	157
PATCHES, DECALS, ETC.	161
PMAG D-60 DRUM POUCH	161
TEJAS GUN BELTS	153
GRIPS	091
AFG ANGLED FORE GRIP	097
AFG-2 ANGLED FORE GRIP	097
GRIP CORES	094
MIAD GEN 1.1	093
MOE GRIP	096
MOE K GRIP	095
MOE K2 GRIP	095
MOE K2+ GRIP	094
MOE SL GRIP	093
MOE+ GRIP	096
RVG RAIL VERTICAL GRIP	098
XTM HAND STOP KIT	098
HAND GUARDS	119
MOE M-LOK HAND GUARDS	122
MOE SL HAND GUARDS	121

RAIL LIGHT MOUNT	123
XTM ENHANCED RAIL PANELS	124
HANDGUN	063
GL-L PLATE	069
MOE 1911 GRIP PANELS, TSP	070
MOE 1911 GRIP PANELS	070
PMAG FLOOR PLATE	068
PMAG 12 GL9	065
PMAG 15 GL9	067
PMAG 17 GL9	067
PMAG 21 GL9	066
PMAG 27 GL9	066
KALASHNIKOV	043
AK CHEEK RISER KITS	052
MOE AK GRIP	051
MOE AK HAND GUARD	050
MOE AK STOCK	048
MOE AK+ GRIP	052
MOE AKM HAND GUARD	050
MOE K-2 AK GRIP	046
MOE SL AK GRIP	046
ZHUKOV HAND GUARD	049
ZHUKOV-U HAND GUARD	045
ZHUKOV-S STOCK	047
ZHUKOV-S YUGO STOCK	048
KALASHNIKOV SYSTEM	053, 054
KNOWLEDGE PRODUCTS	163
PRECISION RIFLE DATA BOOK 2.0	164
PRECISION RIFLE QUICK REFERENCE CARDS	164
MAGAZINE COMPARISON	019, 020
MAGAZINES	005
MEDIUM COYOTE TAN (MCT) PMAGS	007
PMAG 10 AK/AKM MOE	016
PMAG 10 AR/M4 GEN M3	011
PMAG 10 LR/SR GEN M3	014
PMAG 20 AK/AKM MOE	016
PMAG 20 AR/M4 GEN M3	011
PMAG 20 LR/SR GEN M3	014
PMAG 25 LR/SR GEN M3, WINDOW	013
PMAG 25 M118 LR/SR GEN M3, WINDOW	013
PMAG 30 AK/AKM GEN M3	015
PMAG 30 AK/AKM MOE	015
PMAG 30 AK74 MOE	017
PMAG 30 AR/M4 GEN M2 MOE	012
PMAG 30 AR/M4 GEN M2 MOE, WINDOW	012
PMAG 30 AR/M4 GEN M3	010
PMAG 30 AR 300 B GEN M3	008
PMAG 30 AR/M4 GEN M3, WINDOW	010
PMAG 30 AUS GEN M3, WINDOW	018
PMAG 30 SPC GEN M3, WINDOW	017
PMAG 30G	018
PMAG 40 AR/M4 GEN M3	009
PMAG D-60	009

MAGAZINE ACCESSORIES	058
DUMMY ROUNDS	026
MAGLINK	023
ORIGINAL MAGPUL	022
PMAG FLOOR PLATES	021
PMAG ROUND LIMITERS	024
RANGER PLATE	024
SPEED PLATE	026
USGI ENHANCED SELF-LEVELING FOLLOWER	025
USGI L-PLATE	025
MAGPUL CORE	165
M-LOK ACCESSORIES	103
LIGHT MOUNT V-BLOCK AND RINGS	116
M-LOK AFG ANGLED FORE-GRIP	108
M-LOK BIPOD ADAPTER	111
M-LOK CANTILEVER RAIL, ALUMINUM	109
M-LOK CANTILEVER RAIL, POLYMER	109
M-LOK GI SLING SWIVEL	106
M-LOK HAND STOP KIT	113
M-LOK MVG VERTICAL FORE-GRIP	108
M-LOK OFFSET LIGHT MOUNT, POLYMER	110
M-LOK OFFSET LIGHT/OPTIC MOUNT, ALUMINUM	110
M-LOK PARACLIP SLING MOUNT	112
M-LOK QD SLING MOUNT	112
M-LOK RAIL COVER TYPE 1	114
M-LOK RAIL COVER TYPE 2	114
M-LOK RAIL SECTION, ALUMINUM	115
M-LOK RAIL SECTION, POLYMER	115
M-LOK TAPE SWITCH MOUNTING PLATE, INSIGHT PEQ	105
M-LOK TAPE SWITCH MOUNTING PLATE	111
M-LOK TRIPOD ADAPTER	107
M-LOK TO MOE ADAPTER	116
T-NUT REPLACEMENT SET	116
M-LOK SYSTEM	117, 118
MOE SYSTEM	099, 100
SHOTGUN	055
FORWARD SLING MOUNT	059
HUNTER-SGA CHEEK RISER KITS	060
MOE M-LOK SHOTGUN FORENDS	057
SGA OEM BUTT-PAD ADAPTER	060
SGA RECIEVER SLING MOUNT	059
SGA SHOTGUN STOCK	058
RIMFIRE	035
HUNTER X-22	040
HUNTER X-22 TAKEDOWN	039
X-22 BACKPACKER	037
SIGHTS	127
MBUS ENHANCED FRONT SIGHT POST	132
MBUS FRONT	129
MBUS PRO FRONT	130
MBUS PRO LR	132
MBUS PRO OFFSET FRONT	131
MBUS PRO OFFSET REAR	131
MBUS PRO REAR	130
MBUS REAR	129

SLING SYSTEMS	133
ASAP	139
ASAP-QD	139
MS1 MS3 ADAPTER	136
MS1 MS3-QD ADAPTER	136
MS1 MS4 ADAPTER	136
MS1 PADDED SLING	135
MS1 SLING	135
MS3 GEN 2 SLING	137
MS3 SINGLE QD GEN 2 SLING	138
MS4 DUAL QD GEN 2 SLING	138
MSA-QD MOE SLING ATTACHMENT	140
PARACLIP	136
PRS QD FOOTMAN'S LOOP	140
QD PARACLIP ADAPTER	136
QD SLING SWIVEL	136
QDM QUICK DISCONNECT SLING MOUNT	137
RSA RAIL SLING ATTACHMENT	140
RSA-QD RAIL SLING ATTACHMENT	140
STOCK COMPARISON	083, 084
STOCKS	073
ACS CARBINE STOCK	079
ACS-L CARBINE STOCK	079
AR15/M4 BUFFER TUBES	086
AR15/M4 CARBINE BUFFER SPRING	086
AR15/M16 RIFLE BUFFER SPRING	086
CHEEK RISERS	088
CTR CARBINE STOCK	078
ENHANCED BUTT-PAD	087
ENHANCED RECEIVER EXTENSION	086
MOE SL ENHANCED BUTT-PAD	087
MOE CARBINE STOCK	077
MOE FIXED CARBINE STOCK	077
MOE RIFLE STOCK	082
MOE SL CARBINE STOCK	076
MOE SL-K CARBINE STOCK	076
MOE SL-S CARBINE STOCK	075
HEAT-TREATED CASTLE NUT	085
PRS EXTENDED BUTT-PAD	087
PRS2 EXTENDED BUTT-PAD	087
PRS2 RIFLE STOCK	082
PRS GEN3 RIFLE STOCK	081
QD SLING MOUNTS	088
RECIEVER END PLATE	085
REPLACEMENT BUTT-PADS	087
STR CARBINE STOCK	078
UBR GEN2 CARBINE STOCK	080
TOOLS	141
ARMORER'S WRENCH	142
BEV BLOCK	142
SPEED THREADER	142

EVERYWHERE: 



EVERYWHERE: MAGPUL



MAGPUL INDUSTRIES CORP.

TEL: 877.4.MAGPUL
FAX: 303.828.3469
EMAIL: INFO@MAGPUL.COM
WEB: MAGPUL.COM
CAGE: 1LX50